

TSG-641
9 May 2005

**Proposed Revision of
ATSC Standard A/65B
Program and System Information Protocol for
Terrestrial Broadcast and Cable**

Advanced Television Systems Committee

1750 K Street, N.W.

Suite 1200

Washington, D.C. 20006

<http://www.atsc.org>

The Advanced Television Systems Committee, Inc., is an international, non-profit organization developing voluntary standards for digital television. The ATSC member organizations represent the broadcast, broadcast equipment, motion picture, consumer electronics, computer, cable, satellite, and semiconductor industries.

Specifically, ATSC is working to coordinate television standards among different communications media focusing on digital television, interactive systems, and broadband multimedia communications. ATSC is also developing digital television implementation strategies and presenting educational seminars on the ATSC standards.

ATSC was formed in 1982 by the member organizations of the Joint Committee on InterSociety Coordination (JCIC): the Electronic Industries Association (EIA), the Institute of Electrical and Electronic Engineers (IEEE), the National Association of Broadcasters (NAB), the National Cable Television Association (NCTA), and the Society of Motion Picture and Television Engineers (SMPTE). Currently, there are approximately 140 members representing the broadcast, broadcast equipment, motion picture, consumer electronics, computer, cable, satellite, and semiconductor industries.

ATSC Digital TV Standards include digital high definition television (HDTV), standard definition television (SDTV), data broadcasting, multichannel surround-sound audio, and satellite direct-to-home broadcasting.

Table of Contents

1. SCOPE	9
1.1 Application	9
1.1.1 Terrestrial Broadcast	9
1.1.2 Cable	10
1.2 Organization	10
2. REFERENCES	11
2.1 Normative References	11
2.2 Informative References	11
3. DEFINITIONS	12
3.1 Compliance Notation	12
3.2 Acronyms and Abbreviations	12
3.3 Definition of Terms	13
3.4 Section and Data Structure Syntax Notation	15
4. DATA STRUCTURE	15
4.1 Table Format	15
4.2 Extensibility	17
4.3 User Private Ranges	18
4.4 Reserved Fields	18
5. TABLE HIERARCHY AND STRUCTURE REQUIREMENTS	18
5.1 Requirements for Terrestrial Broadcast	21
5.2 Requirements for Cable	21
6. SPECIFICATIONS.....	22
6.1 System Time Table (STT)	22
6.2 Master Guide Table (MGT)	23
6.2.1 Descriptors in the MGT Outer Loop	27
6.2.2 Descriptors in the MGT Inner Loop	27
6.2.3 Descriptor Precedence	27
6.3 Virtual Channel Table (VCT)	27
6.3.1 Terrestrial Virtual Channel Table	28
6.3.2 Cable Virtual Channel Table	34
6.4 Rating Region Table (RRT)	37
6.5 Event Information Table (EIT)	40
6.6 Extended Text Table (ETT)	44
6.7 Directed Channel Change Table (DCCT)	46
6.7.1 Temporary Retune DCC	49

6.7.2	Channel Redirect DCC	49
6.7.3	Case: Unconditional Channel Change (dcc_selection_type = 0x00)	56
6.7.4	Case: Numeric Postal Code (dcc_selection_type = 0x01, 0x11)	56
6.7.5	Case: Alphanumeric Postal Code (dcc_selection_type = 0x02, 0x12)	56
6.7.6	Case: Demographic Category (dcc_selection_type = 0x05, 0x06, 0x15, 0x16)	57
6.7.7	Case: Genre Category (dcc_selection_type = 0x07, 0x08, 0x17, 0x18)	58
6.7.8	Case: Cannot Be Authorized (dcc_selection_type = 0x09)	61
6.7.9	Case: Geographic Location (dcc_selection_type = 0x0C, 0x1C)	62
6.7.10	Case: Rating Blocked (dcc_selection_type = 0x0D)	63
6.7.11	Case: Return to Original Channel (dcc_selection_type = 0x0F)	63
6.7.12	Case: Viewer-Direct-Select (dcc_selection_type = 0x20 – 0x23)	63
6.7.13	Viewer-Direct-Select Persistence	63
6.8	DCC Selection Code Table (DCCSCT)	65
6.9	Core Descriptors	68
6.9.1	AC-3 Audio Descriptor	70
6.9.2	Caption Service Descriptor	70
6.9.3	Content Advisory Descriptor	71
6.9.4	Extended Channel Name Descriptor	73
6.9.5	Service Location Descriptor	73
6.9.6	Time-Shifted Service Descriptor	75
6.9.7	Component Name Descriptor	76
6.9.8	Stuffing Descriptor	77
6.9.9	Descriptors for Inactive Channels	77
6.9.10	DCC Departing Request Descriptor	77
6.9.11	DCC Arriving Request Descriptor	78
6.9.12	Redistribution Control (RC) Descriptor	79
6.9.14	Genre Descriptor	80
6.10	Multiple String Structure	81
7.	PSIP STD MODEL.....	85
7.1	Buffer Model for Terrestrial Broadcast	85
7.2	Buffer Model for Cable	85
7.3	Buffer Model Considerations to Support Directed Channel Change for Terrestrial Broadcast	85
ANNEX A:	DAYLIGHT SAVINGS TIME CONTROL (NORMATIVE).....	86
ANNEX B:	ADDITIONAL CONSTRAINTS ON VIRTUAL CHANNEL TABLE FOR THE U.S. (NORMATIVE)	88
1.	ASSIGNMENT OF MAJOR CHANNEL NUMBER VALUES FOR TERRESTRIAL BROADCAST IN THE U.S.	88
2.	REQUIREMENT TO TRANSMIT ANALOG TRANSMISSION SIGNAL ID	89
ANNEX C:	STANDARD HUFFMAN TABLES FOR TEXT COMPRESSION (NORMATIVE)	90

1. SCOPE	90
2. CHARACTER SET DEFINITION	90
2.1 First Order Escape	90
2.2 Decode Table Data Structures	91
2.2.1 Tree Root Byte Offsets	91
2.2.2 Order-1 Decode Trees	91
3. STANDARD COMPRESSION TYPE 1 ENCODE/DECODE TABLES	93
4. STANDARD COMPRESSION TYPE 2 HUFFMAN ENCODE/DECODE TABLES	101
ANNEX D: AN OVERVIEW OF PSIP FOR TERRESTRIAL BROADCAST WITH APPLICATION EXAMPLES (INFORMATIVE)	109
1. INTRODUCTION	109
2. OVERVIEW	109
3. ELEMENTS OF PSIP	109
4. APPLICATION EXAMPLE	113
4.1 The Master Guide Table (MGT)	114
4.2 The Virtual Channel Table (VCT)	115
4.3 The Event Information Tables (EITs)	119
4.4 The Rating Region Table (RRT)	120
5. PACKETIZATION AND TRANSPORT	121
6. TUNING OPERATIONS AND TABLE ACCESS	121
7. GPS TIME	123
8. NVOD EXAMPLES	124
9. INTERPRETATION OF MGT TABLE VERSION NUMBERS	126
10. USE OF ANALOG TRANSMISSION SIGNAL ID	128
11. USE OF COMPONENT NAME DESCRIPTOR	128
ANNEX E: TYPICAL SIZE OF PSIP TABLES (INFORMATIVE)	129
1. OVERVIEW	129
2. SYSTEM TIME TABLE (STT)	129
3. MASTER GUIDE TABLE (MGT)	129
4. TERRESTRIAL VIRTUAL CHANNEL TABLE (TVCT)	129
5. RATING REGION TABLE (RRT)	130
6. EVENT INFORMATION TABLE (EIT)	130
7. EXTENDED TEXT TABLE (ETT)	131
8. DIRECTED CHANNEL CHANGE TABLE (DCCT)	131

9. DIRECTED CHANNEL CHANGE SELECTION CODE TABLE (DCCSCT)	132
10. AN EXAMPLE FOR TERRESTRIAL BROADCAST	132
ANNEX F: AN OVERVIEW OF HUFFMAN-BASED TEXT COMPRESSION (INFORMATIVE)	134
1. INTRODUCTION	134
2. DATA COMPRESSION OVERVIEW	134
3. OVERVIEW OF CONTEXT-SENSITIVE HUFFMAN CODING	134
3.1 Example	135
3.2 Decode Tree Example	137
3.3 Encoding/Character Decoding Examples with 1st-order Huffman tables	137
ANNEX G: AN OVERVIEW OF PSIP FOR CABLE (INFORMATIVE)	140
1. INTRODUCTION	140
2. OVERVIEW	140
3. COMPARING CVCT AND TVCT	140
3.1 Path Select	140
3.2 Out of Band	141
3.3 Major and Minor Channel Numbers	141
3.4 Source IDs	141
4. IN-BAND VERSUS OUT-OF-BAND SYSTEM INFORMATION	141
5. USING PSIP ON CABLE	142
5.1 Terrestrial Virtual Channel Maps on Cable	142
5.2 Use of the Cable VCT	142
5.3 Service Location on Cable	143
5.4 Analog Channel Sharing	144
6. RE-MULTIPLEXING ISSUES	144
7. THE TRANSITION TO PSIP ON CABLE IN THE UNITED STATES OF AMERICA	145
8. DATA RATES FOR PSIP ON CABLE	145
ANNEX H: LOCATION CODES FOR COUNTIES AND EQUIVALENT ENTITIES OF THE UNITED STATES, ITS POSSESSIONS, AND ASSOCIATED AREAS	147

Index of Tables and Figures

Table 4.1 Generic Table Format Used in PSIP	15
Table 4.2 Table ID Ranges and Values (Informative)	16
Table 6.1 Bit Stream Syntax for the System Time Table	22
Table 6.2 Bit Stream Syntax for the Master Guide Table	25
Table 6.3 Table Types	26
Table 6.4 Bit Stream Syntax for the Terrestrial Virtual Channel Table	29
Table 6.5 Modulation Modes	32
Table 6.6 ETM Location	33
Table 6.7 Service Types	33
Table 6.8 Bit Stream Syntax for the Cable Virtual Channel Table	36
Table 6.9 Path Select	37
Table 6.10 Bit Stream Syntax for the Rating Region Table	38
Table 6.11 Bit Stream Syntax for the Event Information Table	42
Table 6.12 ETM Location	43
Table 6.13 Bit Stream Syntax for the Extended Text Table	44
Table 6.14 ETM ID	45
Table 6.15 Bit Stream Syntax for the Directed Channel Change Table	47
Table 6.16 DCC Context	49
Table 6.17 DCC Selection Type Assignments	52
Table 6.18 Demographic Selection Type Assignments	57
Table 6.19 Examples of Selection Code Packing	58
Table 6.20 Categorical Genre Code Assignments	60
Table 6.21 Conditional Type Value Format	62
Table 6.22 County Subdivision Coding	62
Table 6.23 Bit Stream Syntax for the DCC Selection Code Table	66
Table 6.24 Update Type Coding	67
Table 6.25a List and Location of PSIP Descriptors	69
Table 6.25b List and Location of PSIP Descriptors	69
Table 6.26 Bit Stream Syntax for the Caption Service Descriptor	70
Table 6.27 Stream Syntax for the Content Advisory Descriptor	72
Table 6.28 Bit Stream Syntax for the Extended Channel Name Descriptor	73
Table 6.29 Bit Stream Syntax for the Service Location Descriptor	74
Table 6.30 Selected Stream Type Assignments (Informative)	74
Table 6.31 Bit Stream Syntax for the Time Shifted Service Descriptor	75

Table 6.32 Bit Stream Syntax for the Component Name Descriptor	76
Table 6.33 Bit Stream Syntax for the DCC Departing Request Descriptor	77
Table 6.34 DCC Departing Request Type Assignments	78
Table 6.35 Bit Stream Syntax for the DCC Arriving Request Descriptor	78
Table 6.36 DCC Arriving Request Type Assignments	79
Table 6.37 Bit Stream Syntax for the Redistribution Control Descriptor	80
Table 6.38 Stream Syntax for the Genre Descriptor	81
Table 6.39 Bit Stream Syntax for the Multiple String Structure	81
Table 6.40 Compression Types	82
Table 6.41 Modes	84
Table 7.1 Maximum Cycle Time for the STT, MGT, VCT and RRT	85
Table 7.2 Maximum Rate for Each PSIP Packet Stream	85
Table A1 Structure of Daylight Savings Time Control	86
Table A2 Basic Use of Daylight Savings Fields Through the Year	87
Table C1 Characters with Special Definitions	90
Table C2 Decode Table Format	91
Table C3 Decode Tree Format	92
Table C4 English-language Program Title Encode Table	93
Table C5 English-language Program Title Decode Table	97
Table C6 English-language Program Description Encode Table	101
Table C7 English-language Program Description Decode Table	105
Table D1 An Example of EIT Coverage Times	112
Table D2 The First 3-Hour Segment to be Described in VCT and EIT-0	113
Table D3 The Second 3-Hour Segment to be Described in VCT and EIT-1	114
Table D4 Receiver Behavior with Hidden and Hide Guide Attributes	118
Table E1 Symbols	129
Table E2 Typical Size (bytes) of MGT	129
Table E3 Typical TVCT Size (bytes)	130
Table E4 Typical Size (in bytes per rating region) of RRT	130
Table E5 Typical Size (bytes per virtual channel per EIT) of EIT	131
Table E6 Typical Size (bytes per virtual channel or bytes per event) of ETT	131
Table E7 Typical Size (bytes) of DCCT	131
Table E8 Typical Size (bytes) of DCCSCT	132
Table E9 Typical Sizes of PSIP tables (except ETT) for the Example	132
Table E10 Typical Sizes of ETTs for the Example	133
Table F1 Example Character Set and Frequency of Character Occurrence	135

Table F2 Decode Tree Example	137
Figure 5.1 Table hierarchy for the Program and System Information Protocol (PSIP).	19
Figure 5.2 Extended Text Tables (ETTs) defined to carry text messages for describing virtual channels and events.	21
Figure D1 Main Structure for the PSIP tables.	111
Figure D2 Extended Text Tables in the PSIP hierarchy.	112
Figure D3 Content of the Master Guide Table.	115
Figure D4 Content of the Virtual Channel Table.	117
Figure D5 Content of EIT-0 for NBZ-S	119
Figure D6 An Instance of a Rating Region Table (RRT).	120
Figure D7 Packetization and Transport of the PSIP tables.	121
Figure D8 Extraction of the VCT from the Transport Stream.	122
Figure D9 Acquisition of audiovisual components.	123
Figure D10 NVOD Example no. one.	125
Figure D11 NVOD Example #2	126
Figure F1 Example Huffman tree.	136
Figure F2 Coding example for the string “The next”.	138
Figure F3 Huffman tree for prior symbol “x”.	139

Proposed Revision of ATSC Standard A/65B: Program and System Information Protocol for Terrestrial Broadcast and Cable

1. SCOPE

This document¹ defines a Standard for System Information (SI) and Program Guide (PG) data compatible with digital multiplex bit streams constructed in accordance with ISO/IEC 13818-1 (MPEG-2 Systems). The document defines the standard protocol for transmission of the relevant data tables contained within packets carried in the Transport Stream multiplex. The protocol defined herein is referred to as Program and System Information Protocol (PSIP).

This standard was prepared by the Advanced Television Systems Committee (ATSC) Technology Group on Distribution (T3). The document was approved by the members of the ATSC on 23 December 1997. Revision B to PSIP is the result of incorporating Amendment No. 1A (12 August 2002), Amendment No. 2 (6 August 2002), and Amendment No. 3 (1 April 2002) after their approval by the full ATSC. In addition, further clarifications were incorporated to produce this document. ATSC Standard A/65B was approved by the full membership on (date).

For an informative description of the purpose, concepts, and tables defined in this protocol, first-time readers are encouraged to start with Annex D. In addition, a Recommended Practice on PSIP implementation is available as ATSC document A/69, "ATSC Recommended Practice: Program and System Information Protocol Implementation Guidelines for Broadcasters" [13]. A companion document for receiver manufacturers is available from the Consumer Electronics Association: "CEA-CEB12 PSIP Recommended Practice" [16].

1.1 Application

This document describes tables that shall be applicable to terrestrial (over-the-air) and cable signals. Some PSIP tables apply to terrestrial broadcast, some apply to cable, and others apply to both.

1.1.1 Terrestrial Broadcast

The following PSIP data shall be included in all ATSC-compliant Transport Streams to be transmitted via terrestrial broadcast:

- The Terrestrial Virtual Channel Table (TVCT) defining, at a minimum, MPEG-2 programs embedded in the Transport Stream in which the TVCT is carried.
- The Master Guide Table (MGT) defining the type, packet identifiers, and versions for all the other PSIP tables in this Transport Stream, except for the System Time Table (STT).

¹ NOTE: The user's attention is called to the possibility that compliance with this standard may require use of an invention covered by patent rights. By publication of this standard, no position is taken with respect to the validity of this claim, or of any patent rights in connection therewith. The patent holder has, however, filed a statement of willingness to grant a license under these rights on reasonable and nondiscriminatory terms and conditions to applicants desiring to obtain such a license. Details may be obtained from the publisher. This document will undergo periodic review and may be subject to change by ballot of the ATSC membership

- The Rating Region Table (RRT) defining the TV parental guideline (rating information) system referenced by any content advisory descriptor carried within the Transport Stream, except the RRT corresponding to rating_region 0x01 (US + possessions).²
- The System Time Table (STT), defining the current date and time of day.
- A service_location_descriptor for each digital virtual channel in the VCT.
- The first four Event Information Tables (EIT-0, EIT-1, EIT-2 and EIT-3) describing 12 hours of events (TV programs), each with a coverage of 3 hours, and including all of the virtual channels listed in the TVCT.

1.1.2 Cable

The following PSIP data shall be included in all ATSC-compliant Transport Streams to be transmitted via cable:

- The Cable Virtual Channel Table (CVCT) defining, at a minimum, the virtual channel structure for the collection of MPEG-2 programs embedded in the Transport Stream in which the CVCT is carried.
- The Master Guide Table (MGT) defining the type, packet identifiers, and versions for all of the other PSIP tables included in this Transport Stream except for the System Time Table (STT).
- The Rating Region Table (RRT) defining the TV parental guideline system (rating information) referenced by any content advisory descriptor carried within the Transport Stream, except the RRT corresponding to rating_region 0x01 (US + possessions).³
- The System Time Table (STT), defining the current date and time of day.

1.2 Organization

The sections of this document are organized as follows:

- **Section 1** — Provides this general introduction.
- **Section 2** — Lists references and applicable documents.
- **Section 3** — Provides a definition of terms and a list of acronyms and abbreviations used in this document.
- **Section 4** — Describes the data structure of the PSIP tables.
- **Section 5** — Describes the overall table hierarchy.
- **Section 6** — Describes formats for all of the PSIP tables.
- **Section 7** — Describes PSIP STD model.
- **Annex A** — Describes the daylight savings time control.
- **Annex B** — Describes the assignment of major_channel_number values for terrestrial broadcast in the U.S.
- **Annex C** — Describes the standard Huffman tables for text compression.

² Note: Interpretation in a receiver of the rating_region 0x01 RRT requires prior knowledge of CEA-766-A [17]; therefore transmission is unnecessary. A future extension or replacement of the content advisory system for the U.S. is possible by assignment of a new, different rating_region code and creation of new content for an RRT.

³ See footnote 2.

- **Annex D** — Provides an overview of PSIP for terrestrial broadcast with application examples.
- **Annex E** — Describes the typical sizes of PSIP tables.
- **Annex F** — Provides an overview of Huffman-based text compression.
- **Annex G** — Provides an overview of the use of PSIP for cable.

2. REFERENCES

2.1 Normative References

The following documents are normative references to this Standard:

- [1] ATSC Standard A/53D (2005), ATSC Digital Television Standard, Revision D.
- [2] **Editorially removed, as no longer used**
- [3] CEA-608-B, *Line 21 Data Services*. Consumer Electronics Association.
- [4] CEA-708-B, *Digital Television (DTV) Closed Captioning*, Consumer Electronics Association.
- [5] ISO 639.2, Code for the Representation of Names of Languages — Part 2: alpha-3 code, as maintained by the ISO 639/Joint Advisory Committee (ISO 639/JAC), <http://www.loc.gov/standards/iso639-2/iso639jac.html>.
- [6] ISO/IEC 8859, Information Processing — 8-bit Single-Octet Coded Character Sets, Parts 1 through 10.
- [7] ISO/IEC 10646-1:2000, Information technology — Universal Multiple-Octet Coded Character Set (UCS) — Part 1: Architecture and Basic Multilingual Plane.
- [8] ITU-T Rec. H.222.0 | ISO/IEC 13818-1:2000, Information Technology — Generic coding of moving pictures and associated audio — Part 1: Systems.
- [9] ITU-T Rec. H.262 | ISO/IEC 13818-2:2000, Information Technology — Generic coding of moving pictures and associated audio — Part 2: Video.
- [10] The Unicode Standard, Version 3.0, The Unicode Consortium, Addison-Wesley Pub., ISBN 0201616335.
- [11] Unicode Technical Report #6, A Standard Compression Scheme for Unicode, Revision 3.0, 1999-11-12, The Unicode Consortium.
- [12] U.S. Code of Federal Regulations (CFR) Title 47, Part 11, Emergency Alert System (EAS), U.S. Government Printing Office, Washington, DC 20040, <http://www.fcc.gov/wtb/rules.html>.
- [13] U.S. Code of Federal Regulations (CFR) Title 47, Part 73, Broadcast Radio Services, U.S. Government Printing Office, Washington, DC 20040, <http://www.fcc.gov/wtb/rules.html>.

2.2 Informative References

- [14] ATSC A/90 (2000), Data Broadcast Standard.

[15] Editorially removed

- [16] CEA-CEB12 PSIP Recommended Practice, Consumer Electronics Association, September 2002.
- [17] CEA-766-A Specification for U.S. and Canadian Rating Region Table (RRT) and Content Advisory Descriptor for Transport of Content Advisory Information Using ATSC A/65A Program and System Information Protocol (PSIP), Consumer Electronics Association, April 2001.
- [18] Federal Information Processing Standard, FIPS Pub 6-4, Counties and Equivalent Entities of the U.S., Its Possessions, and Associated Areas — 90 Aug 31, U.S. Government Printing Office, Washington, DC 20040, <http://www.itl.nist.gov/fipspubs>.
- [19] ISO/IEC 11172-2:1993, Information technology -- Coding of moving pictures and associated audio for digital storage media at up to about 1.5 Mbit/s -- Part 2: Video.
- [20] ANSI/SCTE 07 2000, Digital Video Transmission Standard for Cable Television, Society of Cable Telecommunications Engineers, <http://www.scte.org/>.
- [21] U.S. Code of Federal Regulations (CFR) Title 47, Part 15, Radio Frequency Devices, U.S. Government Printing Office, Washington, DC 20040, <http://www.fcc.gov/wtb/rules.html>.

3. DEFINITIONS

3.1 Compliance Notation

As used in this document, “shall” denotes a mandatory provision of the standard. “Should” denotes a provision that is recommended but not mandatory. “May” denotes a feature whose presence does not preclude compliance, that may or may not be present at the option of the implementer.

3.2 Acronyms and Abbreviations

The following acronyms and abbreviations are used within this specification:

ATSC	Advanced Television Systems Committee
bslbf	bit serial, leftmost bit first
BMP	basic multilingual plane
CAT	conditional access table
CRC	cyclic redundancy check
CVCT	cable virtual channel table
DCC	directed channel change
DCCRR	DCC capable DTV reference receiver
DCCSCT	DCC selection code table
DET	data event table
DTV	digital television
EPG	electronic program guide

EIT	event information table
EMM	entitlement management message
ETM	extended text message
ETT	extended text table
GPS	Global Positioning System
PSIP	Program and System Information Protocol
MGT	master guide table
MPIA	Motion Picture Association of America
MPEG	Moving Picture Experts Group
NVOD	near video on demand
OOB	out of band
PAT	program association table
PCR	program clock reference
PES	packetized elementary stream
PID	packet identifier
PMT	program map table - The collection of all the TS_program_map_section(s).
PTC	physical transmission channel
SCTE	Society of Cable Telecommunications Engineers
SI	system information
STD	system target decoder
STT	system time table
rpchof	remainder polynomial coefficients, highest order first
RRT	rating region table
TS	transport stream
TVCT	terrestrial virtual channel table
unicode	Unicode™
UTC	Coordinated Universal Time ⁴
uimsbf	unsigned integer, most significant bit first
VCT	virtual channel table. Used in reference to either TVCT or CVCT.

3.3 Definition of Terms

The following terms are used throughout this document:

descriptor A data structure of the format: descriptor_tag, descriptor_length, and a variable amount of data. The tag and length fields are each 8 bits. The length specifies the length of data that begins immediately following the descriptor_length field itself. A descriptor whose descriptor_tag identifies a type not recognized by a particular decoder shall be ignored by that decoder.

⁴ Since unanimous agreement could not be achieved by the ITU on using either the English word order, CUT, or the French word order, TUC, a compromise to use neither was reached.

Descriptors can be included in certain specified places within PSIP tables, subject to certain restrictions (see Table 6.25). Descriptors may be used to extend data represented as fixed fields within the tables. They make the protocol very flexible since they can be included only as needed. New descriptor types can be standardized and included without affecting receivers that have not been designed to recognize and process the new types.

digital channel A set of one or more digital elementary streams. See *virtual channel*.

event A collection of associated program elements that have a common timeline for a defined period. An event is equivalent to the common industry usage of “television program.” An event may also be an analog “television program.”

instance See *table instance*.

logical channel See *virtual channel*.

physical channel: A generic term to refer to the each of the 6–8 MHz frequency bands where television signals are embedded for transmission. Also known as the physical transmission channel (PTC). One analog virtual channel fits in one PTC but multiple digital virtual channels typically coexist in one PTC.

physical transmission channel See *physical channel*.

program element A generic term for one of the elementary streams or other data streams that may be included in a program. For example: audio, video, data, etc.

program A collection of program elements. Program elements may be elementary streams. Program elements need not have any defined time base; those that do have a common time base are intended for synchronized presentation. The term program is also commonly used in the context of a “television program” such as a scheduled daily news broadcast. In this specification the term “event” is used to refer to a “television program” to avoid ambiguity.

region As used in this document, a region is a geographical area consisting of one or more countries.

section A data structure comprising a portion of an ISO/IEC 13818-1 defined table, such as the Program Association Table (PAT), Conditional Access Table (CAT), or Program Map Table (PMT). All sections begin with the `table_id` and end with the `CRC_32` field, and their starting points within a packet payload are indicated by the `pointer_field` mechanism defined in the ISO/IEC 13818-1 International Standard [8].

stream An ordered series of bytes. The usual context for the term stream is the series of bytes extracted from Transport Stream packet payloads which have a common unique PID value (e.g., video PES packets or Program Map Table sections).

table The collection of re-assembled sections bearing a common table ID and version number.

table instance Tables are identified by the `table_id` field. However, in cases such as the Event Information Table, several instances of a table are defined simultaneously. All instances are conveyed in Transport Stream packets of the same PID value and have the same `table_id` field value. Each instance has a different `table_id_extension` value. The term `table_id_extension` is the generic label for the field per Table 4.1; it is renamed as appropriate for specific tables.

virtual channel A virtual channel is the designation, usually a number, that is recognized by the user as the single entity that will provide access to an analog TV program or a set of one or more digital elementary streams. It is called “virtual” because its identification (name and number) may be defined independently from its physical location. Examples of virtual

channels are: digital radio (audio only), a typical analog TV channel, a typical digital TV channel (composed of one audio and one video stream), multi-visual digital channels (composed of several video streams and one or more audio tracks), or a data broadcast channel (composed of one or more data streams). In the case of an analog TV channel, the virtual channel designation will link to a specific physical transmission channel. In the case of a digital TV channel, the virtual channel designation will link both to the physical transmission channel and to the particular video and audio streams within that physical transmission channel.

3.4 Section and Data Structure Syntax Notation

This document contains symbolic references to syntactic elements. These references are typographically distinguished by the use of a different font (e.g., *restricted*), may contain the underscore character (e.g., *sequence_end_code*) and may consist of character strings that are not English words (e.g., *dynrng*).

The formats of sections and data structures in this document are described using a C-like notational method employed in ISO/IEC 13818-1 [8].

4. DATA STRUCTURE

This section describes the data structure common to all PSIP tables.

4.1 Table Format

Tables defined in this Standard are derived from the “long” form of the MPEG-2 *private_section* defined in sections 2.4.4.10 and 2.4.4.11 of ISO/IEC 13818-1 [8]. The table format common to all PSIP tables is given in Table 4.1. An additional field, *protocol_version*, has been added as a consistent first byte of every PSIP table section.

Table 4.1 Generic Table Format Used in PSIP

Syntax	No. of Bits	Format
PSIP_section() {		
table_id	8	uimsbf
section_syntax_indicator	1	'1'
private_indicator	1	'1'
reserved	2	'11'
section_length	12	uimsbf
table_id_extension	16	uimsbf
reserved	2	'11'
version_number	5	uimsbf
current_next_indicator	1	bslbf
section_number	8	uimsbf
last_section_number	8	uimsbf
protocol_version	8	uimsbf
PSIP_table_data()	*	
CRC_32	32	rpchof
}		

table_id – The value of this 8-bit field shall identify the PSIP Table to which this section belongs. Tables defined in this PSIP Standard, and any created in other ATSC Standards are

considered “private” with respect to ISO/IEC 13818-1 [8] and standard with respect to other ATSC Standards. Table 4.2 lists Table ID ranges and values.

Table 4.2 Table ID Ranges and Values (Informative)

Table ID Value (hex)	Tables	PID	Ref.
ISO/IEC 13818-1 Sections:			
0x00	Program Association Table (PAT)	0x0000	Ref. [9]
0x01	Conditional Access Table (CAT)	0x0001	Ref. [9]
0x02	Program Table (PMT)	per PAT	Ref. [9]
0x03-0x3F	[ISO reserved]		
User Private Sections:			
0x40-0xBF	[User Private]		
Other documents:			
0xC0-0xC6	[ATSC coordinated values which are defined in other standards.]		
PSIP tables:			
0xC7	Master Guide Table (MGT)	0x1FFB	Sec.6.2
0xC8	Terrestrial Virtual Channel Table (TVCT)	0x1FFB	Sec.6.3.1
0xC9	Cable Virtual Channel Table (CVCT)	0x1FFB	Sec.6.3.2
0xCA	Rating Region Table (RRT)	0x1FFB	Sec.6.4
0xCB	Event Information Table (EIT)	per MGT	Sec.6.5
0xCC	Extended Text Table (ETT)	per MGT	Sec.6.6
0xCD	System Time Table (STT)	0x1FFB	Sec.6.1
0xCE-0xD2	[ATSC coordinated values which are defined in other standards.]		
0xD3	Directed Channel Change Table (DCCT)	0x1FFB	Sec.6.7
0xD4	Directed Channel Change Selection Code Table (DCCSCT)	0x1FFB	Sec.6.8
0xD5-0xDF	[ATSC coordinated values which are defined in other standards.]		
0xE0-0xE5	[Used in other systems]		
0xE6-0xFE	[Reserved for future ATSC use]		

section_syntax_indicator – This 1-bit field shall be set to ‘1’ to always indicate the “long” form of the MPEG-2 private_section table.

private_indicator – This 1-bit field shall be set to ‘1’.

private_section_length – A 12-bit field. It specifies the number of remaining bytes in the private section immediately following this field up to and including the CRC_32 field. The value in this field shall not exceed 4093 (0xFFD).

table_id_extension – This is a 16-bit field and is table-dependent. It shall be considered to be logically part of the table_id field providing the scope for the remaining fields.

version_number – This 5-bit field is the version number of the PSIP_section. The version_number shall be incremented by 1 modulo 32 when a change in the information carried within the PSIP_section occurs. When the current_next_indicator is set to '0', then the version_number shall be

that of the next applicable PSIP_section with the same table_id, table_id_extension, and section_number.

current_next_indicator – A 1-bit field, which when set to '1' indicates that the PSIP_section sent is currently applicable. When the current_next_indicator is set to '1', then the version_number shall be that of the currently applicable PSIP_section. When the bit is set to '0', it indicates that the PSIP_section sent is not yet applicable and shall be the next PSIP_section with the same section_number, table_id_extension, and table_id to become valid.

section_number – This 8-bit field gives the number of the PSIP_section. The section_number of the first section in a PSIP table shall be 0x00. The section_number shall be incremented by 1 with each additional section in PSIP table. The scope of the section_number shall be defined by the table_id and table_id_extension. That is, for each PSIP table and value of the table_id_extension field, there is the potential for the full range of section_number values.

last_section_number – This 8-bit field specifies the number of the last section (that is, the section with the highest section_number) of the PSIP table of which this section is a part. Its scope is the same as for the section_number field.

protocol_version – An 8-bit unsigned integer field whose function is to allow, in the future, this table type to carry parameters that may be structured differently than those defined in the current protocol. At present, the only valid value for protocol_version is zero. Non-zero values of protocol_version may be used by a future version of this standard to indicate structurally different tables.

CRC_32 – This is a 32-bit field that contains the CRC value that gives a zero output of the registers in the decoder defined in ISO/IEC 13818-1[8], Annex A after processing the entire private section.

Note that individual PSIP tables defined in this Standard may further constrain the above fields. But when not further constrained in each table, the above semantics shall apply.

4.2 Extensibility

The PSIP protocol describes a number of tables conveying system information and content guide data structures. The Standard is designed to be extensible via the following mechanisms:

Reserved fields – Fields in this Standard marked reserved shall be reserved for use either when revising this Standard, or when another standard is issued that builds upon this one. See Section 4.4.

Standard table types – As indicated in Table 4.2, table_id values in the range 0xCE-0xDF and 0xE6-0xFE shall be reserved for use either when revising this PSIP Standard, or when another standard is issued.

Protocol version field – Future substantive structural modifications shall be accommodated by defining different protocol version numbers. Backwards compatible additions or modifications may be added without incrementing the protocol version number.

Table length extensions – Future amendments to this Standard may include new fields at the ends of certain tables. Tables that may be extensible in this way include those in which the last byte of the field just preceding the CRC may be determined without use of the section_length field. Such an extension is a backwards compatible addition.

Descriptor length extensions – Future amendments to this Standard may include new fields at the ends of certain descriptors. Descriptors extensible in this way include those in which the last byte of the last currently defined field may be determined without the use of the descriptor_length field.

4.3 User Private Ranges

Certain fields in this Standard are defined to include “user private” ranges:

- table_ID values in the range 0x40 through 0xBF
- MGT table_type values in the range 0x0400 through 0x0FFF

Table sections with table_ID values in the user private range (0x40 through 0xBF) shall not appear in transport packets identified with the base_PID PID value (0x1FFB). The MGT may refer to private table sections with any value of table_ID including values in the user private range. Refer to Section 6.2 for a discussion of the use of the MPEG-2 Registration Descriptor in the MGT with respect to delivery of private table sections.

4.4 Reserved Fields

reserved — Fields in this PSIP Standard marked “reserved” shall not be assigned by the user, but shall be available for future use. Decoders are expected to disregard reserved fields for which no definition exists that is known to that unit. Each bit in the fields marked “reserved” shall be set to one until such time as it is defined and supported.

5. TABLE HIERARCHY AND STRUCTURE REQUIREMENTS

The Program and System Information Protocol (PSIP) is a collection of hierarchically arranged tables for describing system information and program guide data. These tables are packetized and multiplexed according to the transport protocol detailed in ISO/IEC 13818-1[8].

The base PID (base_PID) is an explicitly defined value (0x1FFB) used to identify the TS packets for the following tables for terrestrial and cable systems⁵:

- The System Time Table (STT)
- Master Guide Table (MGT)
- Rating Region Table (RRT)
- Virtual Channel Table (VCT)
- The optional Directed Channel Change Table (DCCT)
- The optional Directed Channel Change Selection Code Table (DCCSCT)

Several Event Information Tables (EIT) are also part of the PSIP data structures, with their PIDs explicitly defined in the MGT. Figure 5.1 illustrates the relations between these elements.

⁵ The ATSC DTV Standards do not define a Network Information Table (NIT) as specified in MPEG-2 Systems. The use of program_number 0x0000 in the PAT to point to the PSIP base_PID (0x1FFB) should be avoided as MPEG-2 Systems reserves this value for the network_PID, which in turn is used to identify the TS packets of a NIT. See A/53D [1], Annex C for further details.

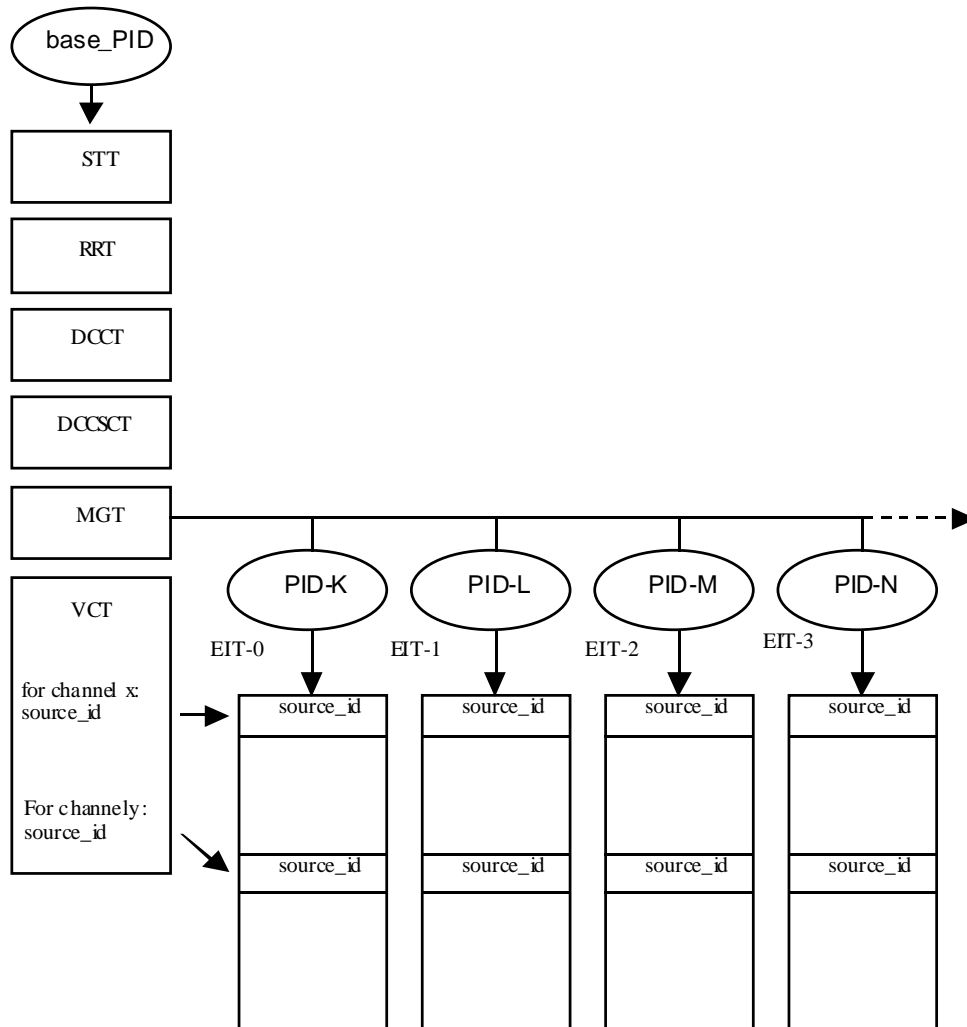

Figure 5.1 Table hierarchy for the Program and System Information Protocol (PSIP).

As the name indicates, the System Time Table (STT) carries time information needed for any application requiring synchronization. The Rating Region Table (RRT) defines rating tables valid for different regions or countries. The Master Guide Table (MGT) defines sizes, PIDs, and version numbers for all of the relevant tables. The Virtual Channel Table (VCT) actually exists in two versions: one for terrestrial and a second one for cable applications. Its purpose is to tabulate virtual channel attributes required for navigation and tuning. The terrestrial and cable versions are similar in structure, with the latter redefining the semantics of some fields pertinent to cable operations. The optional Directed Channel Change Table carries requests for a receiver to switch to specified virtual channels at specified times under specified circumstances. The optional Directed Channel Change Selection Code Table permits extension of the basic genre category and location code tables defined here.

Each of the Event Information Tables (EITs) lists TV programs (events) for the virtual channels described in the VCT. The EITs are sequentially and chronologically organized from EIT-0 to EIT-127. The first table (EIT-0) corresponds to the currently valid list of events. The second table (EIT-1) corresponds to the next time window, and so on.

During remultiplexing, EIT tables which originally existed in separate Transport Streams may be multiplexed into a common Transport Stream or *vice versa*. For this reason, it is very convenient to synchronize the start times and durations of the EITs. Consequently, the next three synchronization rules shall be followed when EIT tables are prepared.

- **Requirement 1:** Each EIT shall have a duration of 3 hours.
- **Requirement 2:** Start times for EITs are restricted to 0:00 (midnight), 3:00, 6:00, 9:00, 12:00 (noon), 15:00, 18:00 and 21:00. All of these times are UTC.
- **Requirement 3:** EIT-0 lists all of the available events for the current 3-hour time segment. EIT-1 lists all of the available events for the next 3-hour time segment, and likewise, non-overlapping sequential time windows are allocated for all of the other EITs.

For example, a broadcast group operating in the Eastern time zone of the U.S. at 15:30 EDT (19:30 UTC) is required to carry EIT-0 describing events from 14:00 to 17:00 EDT (18:00 to 21:00 in UTC time) plus EIT-1, EIT-2, and EIT-3 covering the next 9-hour interval between 17:00 to 2:00 EDT. At 17:00 EDT, the first table, EIT-0, will be obsolete while EIT-1 will still be valid. At this time, simply by shifting the listed PID values in the MGT, EIT-1 becomes EIT-0 and EIT-2 becomes EIT-1. Updating tables then becomes a process of shifting the list of PIDs in the MGT and their corresponding version numbers. However, updates and/or corrections to the information in the EITs may be performed at any time since the decoder monitors the MGT continuously, where the most current copy of the version number is maintained. Updates and/or corrections to the EIT (other than shifting) shall be signaled by increasing the version number by one.

Besides listing the PIDs for all of the EITs, the Master Guide Table (MGT) also lists a set of PIDs for Extended Text Tables (ETTs). The ETTs carry relatively long text messages for describing events and virtual channels. Each EIT has either zero or one associated ETT. Similarly, The VCT has either zero or one associated ETT. Figure 5.2 illustrates the concept.

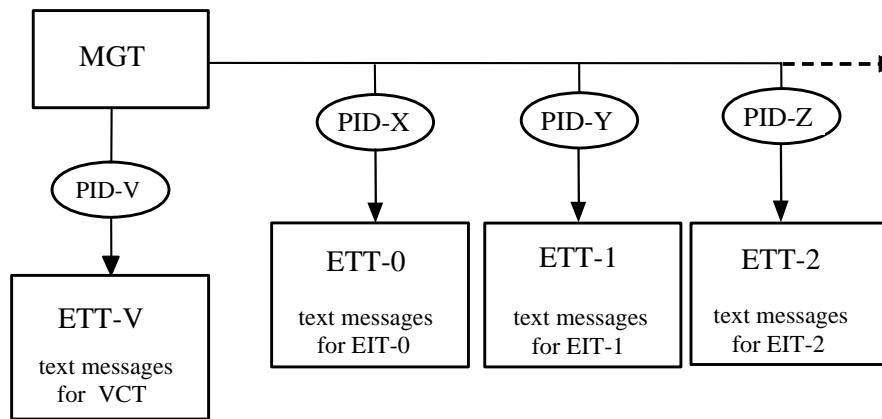

Figure 5.2 Extended Text Tables (ETTs) defined to carry text messages for describing virtual channels and events.

5.1 Requirements for Terrestrial Broadcast

The rules governing the transport of PSIP tables for terrestrial broadcast are:

- **Requirement 4:** Every digital Transport Stream in terrestrial broadcast shall include the STT, the TVCT, the MGT, and the first four Event Information Tables (EIT-0, EIT-1, EIT-2 and EIT-3)⁶. The CVCT, all of the other EITs and the whole collection of ETTs may be present but are not required. An RRT defining the rating system for a given region shall be included in the TS if any content_advisory_descriptor in use refers to that region, unless that region has explicit standards that define the rating system and the meaning of the values in the content_advisory_descriptor.
- **Requirement 5:** The PSIP tables shall describe all of the digital channels multiplexed in the Transport Stream. For convenience, the tables may optionally include information about analog channels as well as other digital channels available in different Transport Streams.

5.2 Requirements for Cable

The rules governing the transport of PSIP tables for cable are:

- **Requirement 6:** The required tables for a cable system are: the STT, either the CVCT or the TVCT, and the MGT. For any region that makes use of the capability to change the RRT, that RRT shall be included in the TS if any content_advisory_descriptor in use refers to that region. An RRT defining the rating system for a given region shall be included in the TS if any content_advisory_descriptor in use refers to that region, unless that region has explicit standards that define the rating system and the meaning of the values in the content_advisory_descriptor.
- **Requirement 7:** The PSIP tables shall describe all of the digital channels multiplexed in the Transport Stream. For convenience, the tables may optionally include information

⁶ Exception: test signals may or may not be included in EIT/ETT data.

about analog channels as well as other digital channels available in different Transport Streams.

6. SPECIFICATIONS

This chapter describes the bit stream syntax and semantics for the System Time Table (STT), Master Guide table (MGT), Virtual Channel Table (VCT), Rating Region Table (RRT), Event Information Table (EIT), Extended Text Table (ETT), the optional Directed Channel Change Table (DCCT), the optional Directed Channel Change Selection Code Table (DCCSCT), core descriptors, and the multiple string structure.

6.1 System Time Table (STT)

The System Time Table provides the current date and time of day information.

The following constraints apply to the Transport Stream packet carrying the STT:

- PID for STT shall have the value 0x1FFB (base_PID)
- transport_scrambling_control bits shall have the value '00'
- adaptation_field_control bits shall have the value '01'

The bit stream syntax for the System Time Table shall be as shown in Table 6.1.

Table 6.1 Bit Stream Syntax for the System Time Table

Syntax	No. of Bits	Format
system_time_table_section () {		
table_id	8	0xCD
section_syntax_indicator	1	'1'
private_indicator	1	'1'
reserved	2	'11'
section_length	12	uimsbf
table_id_extension	16	0x0000
reserved	2	'11'
version_number	5	'00000'
current_next_indicator	1	'1'
section_number	8	0x00
last_section_number	8	0x00
protocol_version	8	uimsbf
system_time	32	uimsbf
GPS.UTC_offset	8	uimsbf
daylight_savings	16	uimsbf
for (l = 0; l < N; l++) {		
descriptor()		
}		
CRC_32	32	rpchof
}		

table_id — This is an 8-bit field, which shall be set to 0xCD, identifying this table as the System Time Table.

section_syntax_indicator — This 1-bit field shall be set to '1'. It denotes that the section follows the generic section syntax beyond the section length field.

- private_indicator** — This 1-bit field shall be set to ‘1’.
- section_length** — 12-bit field specifying the number of remaining bytes in this section immediately following the section_length field up to the end of the section. The value of the section_length shall be no larger than 1021.
- table_id_extension** — This 16-bit field shall be set to 0x0000.
- version_number** — This 5-bit field shall have a value of zero.
- current_next_indicator** — This 1-bit indicator is always set to ‘1’ for an STT section; the STT sent is always currently applicable.
- section_number** — The value of this 8-bit field shall always be 0x00 (this table is only one section long).
- last_section_number** — The value of this 8-bit field shall always be 0x00.
- protocol_version** — An 8-bit unsigned integer field whose function is to allow, in the future, this table type to carry parameters that may be structured differently than those defined in the current protocol. At present, the only valid value for protocol_version is zero. Non-zero values of protocol_version may be used by a future version of this standard to indicate structurally different tables.
- system_time** — A 32-bit unsigned integer quantity representing the current system time as the number of GPS seconds since 00:00:00 UTC, January 6th, 1980. The count of GPS seconds and leap second count shall be accurate and correct to within plus or minus one second, for a direct main broadcast signal RF receiving device, as timed at the arrival in the decoder of the Transport Stream packet carrying the last byte of the CRC. The STT seconds count should be set to the next second and sent approximately 2T milliseconds before the seconds count is due to increment, where T represents the average number of milliseconds between TS packets identified with the SI base_PID (0x1FFB). If one or more translators and/or repeaters are in the RF delivery path that introduce processing delays that impact the overall STT timing accuracy, the STT timing should be adjusted in the translated/repeated signal.
- GPS.UTC_offset** — An 8-bit unsigned integer that defines the current offset in whole seconds between GPS and UTC time standards. To convert GPS time to UTC, the GPS.UTC_offset is subtracted from GPS time. Whenever the International Bureau of Weights and Measures decides that the current offset is too far in error, an additional leap second may be added (or subtracted), and the GPS.UTC_offset will reflect the change.
- daylight_savings** — Daylight Savings Time Control bytes. Refer to Annex A for the use of these two bytes.
- descriptor()** — Zero or more descriptors, as appropriate, may be included.
- CRC_32** — This is a 32-bit field that contains the CRC value that ensures a zero output from the registers in the decoder defined in Annex A of ISO/IEC 13818-1 “MPEG-2 Systems” [8] after processing the entire System Time Table section.

6.2 Master Guide Table (MGT)

The MGT lists version numbers, length in bytes, and PIDs for all of the PSIP tables with the exception of the STT which works independently from the other tables.

The Master Guide Table is carried in a single section with table ID 0xC7, and obeys the syntax and semantics given in Section 4. The following constraints apply to the Transport Stream packet (or packets) carrying the MGT:

- PID for MGT shall have the value 0x1FFB (base_PID)
- transport_scrambling_control bits shall have the value '00'
- adaptation_field_control bits shall have the value '01'
- payload_unit_start_indicator of the Transport Stream packet carrying the table_id field of the MGT section shall be 1 (first Transport Stream packet of the section)
- pointer_field of the Transport Stream packet carrying the table_id field of the MGT section shall have the value 0x00 (section starts immediately after the pointer_field)

The MGT provides the version_number field of tables it references. For purposes of duplicate detection, the version_number shall be processed in accordance with the MPEG-2 definition of the scope of that field. If the version_number of a table transported in transport packets with a given table_type_PID value changes, that table may be assumed to be changed.

For the EIT and ETT tables, the table_type_version_number given in the MGT must not be interpreted as the table version for the associated timeslot. Refer to Annex D Section 8 for a discussion of this important distinction.

The MGT may refer to private table sections: those with the table_type field set to a value in the user private range (0x0400 through 0x0FFF). The table_type is the only semantic element in the MGT that has a user private range. When a table_type in the private range is present, an MPEG-2 registration_descriptor() (MRD) in accordance with Section 2.6.8 of [9] shall be present to identify the entity defining the private table type. Usage rules for the MRD are specified in Section 6.2.1 through 6.2.3. User private tables shall not be placed into transport packets with the PID value equal to the SI base_PID (0x1FFB).

The bit stream syntax for the Master Guide Table shall be as shown in Table 6.2.

Table 6.2 Bit Stream Syntax for the Master Guide Table

Syntax	No. of Bits	Format
master_guide_table_section () {		
table_id	8	0xC7
section_syntax_indicator	1	'1'
private_indicator	1	'1'
reserved	2	'11'
section_length	12	uimsbf
table_id_extension	16	0x0000
reserved	2	'11'
version_number	5	uimsbf
current_next_indicator	1	'1'
section_number	8	0x00
last_section_number	8	0x00
protocol_version	8	uimsbf
tables_defined	16	uimsbf
for (i=0;i<tables_defined;i++) {		
table_type	16	uimsbf
reserved	3	'111'
table_type_PID	13	uimsbf
reserved	3	'111'
table_type_version_number	5	uimsbf
number_bytes	32	uimsbf
reserved	4	'1111'
table_type_descriptors_length	12	uimsbf
for (k=0;k<N;k++) {		
descriptor()		
}		
}		
reserved	4	'1111'
descriptors_length	12	uimsbf
for (l = 0;l < N;l++) {		
descriptor()		
}		
CRC_32	32	rpchof
}		

table_id — This is an 8-bit field which shall be set to 0xC7, identifying this table as the Master Guide Table.

section_syntax_indicator — This 1-bit field shall be set to '1'. It denotes that the section follows the generic section syntax beyond the section length field.

private_indicator — This 1-bit field shall be set to '1'.

section_length — 12-bit field specifying the number of remaining bytes in this section immediately following the section_length field up to the end of the section. The value of the section_length shall be no larger than 4093.

table_id_extension — This 16-bit field shall be set to 0x0000.

version_number — This 5-bit field is the version number of MGT. The version number shall be incremented by 1 modulo 32 when any field in the `table_types` defined in the loop below or the MGT itself changes.

current_next_indicator — This 1-bit indicator is always set to ‘1’ for the MGT section; the MGT sent is always currently applicable.

section_number — The value of this 8-bit field shall always be 0x00 (this table is only one section long).

last_section_number — The value of this 8-bit field shall always be 0x00.

protocol_version — An 8-bit unsigned integer field whose function shall be to allow, in the future, this table type to carry parameters that may be structured differently than those defined in the current protocol. At present, the only valid value for `protocol_version` is zero. Non-zero values of `protocol_version` may be used by a future version of this standard to indicate structurally different tables.

tables_defined — This 16-bit unsigned has a range of 6 – 370 (for terrestrial) and 2 – 370 for cable.

table_type — This 16-bit unsigned integer specifies the type of table. The values shall be as specified in Table 6.3.

Table 6.3 Table Types

table_type	Meaning
0x0000	Terrestrial VCT with <code>current_next_indicator=1</code>
0x0001	Terrestrial VCT with <code>current_next_indicator=0</code>
0x0002	Cable VCT with <code>current_next_indicator=1</code>
0x0003	Cable VCT with <code>current_next_indicator=0</code>
0x0004	Channel ETT
0x0005	DCCSCT
0x0006-0x00FF	[Reserved for future ATSC use]
0x0100-0x017F	EIT-0 to EIT-127
0x0180-0x01FF	[Reserved for future ATSC use]
0x0200-0x027F	Event ETT-0 to event ETT-127
0x0280-0x0300	[Reserved for future ATSC use]
0x0301-0x03FF	RRT with <code>rating_region</code> 1-255
0x0400-0x0FFF	[User private]
0x1000-0x13FF	[Reserved for future ATSC use]
0x1400-0x14FF	DCCT with <code>dcc_id</code> 0x00 – 0xFF
0x1500-0xFFFF	[Reserved for future ATSC use]

table_type_PID — This 13-bit field specifies the PID for the `table_type` described in the loop.

table_type_version_number — This 5-bit field reflects the version number of the `table_type` described in the loop. The value of this field shall be the same as the `version_number` entered in the corresponding fields of tables and table instances. For example, the value of this field for EIT-3 will be the same as that of the `version_number` that appears in the actual EIT-3. The

version number for the next VCT (`current_next_indicator = 0`) shall be one unit more (modulo 32) than the version number for the current VCT (`current_next_indicator = 1`).

number_bytes — This 32-bit unsigned integer field indicates the total number of bytes used for the `table_type` described in the loop.

table_type_descriptors_length — Total length of the descriptors for the `table_type` described in the loop (in bytes).

descriptor() — Zero or more descriptors, as appropriate, may be included.

descriptors_length — Total length of the MGT descriptor list that follows (in bytes).

CRC_32 — This is a 32-bit field that contains the CRC value that ensures a zero output from the registers in the decoder defined in Annex A of ISO/IEC 13818-1 “MPEG-2 Systems” [8] after processing the entire Master Guide Table section.

6.2.1 Descriptors in the MGT Outer Loop

An MPEG-2 `registration_descriptor()` in accordance with Section 2.6.8 of [9] may be placed in the `descriptors_length` “for” loop in the MGT (the “for” loop following the `descriptors_length` field). When used in this location, the scope of the MRD is all the user private table types referenced in the MGT. At most one MRD shall appear in the `descriptors_length` “for” loop.

6.2.2 Descriptors in the MGT Inner Loop

MPEG-2 `registration_descriptor()`s may be placed in the `table_type_descriptors_length` “for” loop of the MGT (the “for” loop following the `table_type_descriptors_length` field). When used in this location, the scope of the MRD is the individual table type being described in that iteration of the `table_type_descriptors_length` “for” loop. At most one MRD shall appear in any `table_type_descriptors_length` “for” loop.

6.2.3 Descriptor Precedence

When MRDs are found at both levels (`descriptors_length` “for” loop and `table_type_descriptors_length` “for” loop), then the MRD at the `table_type_descriptors_length` “for” loop shall further refine the meaning of the identification provided at the `descriptors_length` “for” loop level (i.e., assume the characteristics set by the higher level MRD and add additional characteristics).

6.3 Virtual Channel Table (VCT)

The Virtual Channel Table (VCT) contains a list of attributes for virtual channels carried in the Transport Stream. Any changes in the virtual channel structure shall be conveyed with a new version number. The basic information contained in the VCT table body includes Transport Stream ID, channel number (major and minor), short channel name, program number, access controlled flag, location field for extended text messages, and service type. Additional information may be carried by descriptors which may be placed in the descriptor loop after the basic information.

The Virtual Channel Table may be segmented into as many as 256 sections. One section may contain information for several virtual channels, but the information for one virtual channel shall not be segmented and put into two or more sections. Thus for each section, the first field after `protocol_version` shall be `num_channels_in_section`.

Each virtual channel is associated with a `program_number`. Every program element associated with that `program_number` shall be considered to be a part of that virtual channel.

6.3.1 Terrestrial Virtual Channel Table

The Terrestrial Virtual Channel Table is carried in private sections with table ID 0xC8, and obeys the syntax and semantics given in Section 4. The following constraints apply to the Transport Stream packets carrying the VCT sections:

- PID for Terrestrial VCT shall have the value 0x1FFB (base_PID)
- transport_scrambling_control bits shall have the value '00'
- adaptation_field_control bits shall have the value '01'

The bit stream syntax for the Terrestrial Virtual Channel Table shall be as shown in Table 6.4.

Table 6.4 Bit Stream Syntax for the Terrestrial Virtual Channel Table

Syntax	No. of Bits	Format
terrestrial_virtual_channel_table_section () {		
table_id	8	0xC8
section_syntax_indicator	1	'1'
private_indicator	1	'1'
reserved	2	'11'
section_length	12	uimsbf
transport_stream_id	16	uimsbf
reserved	2	'11'
version_number	5	uimsbf
current_next_indicator	1	bslbf
section_number	8	uimsbf
last_section_number	8	uimsbf
protocol_version	8	uimsbf
num_channels_in_section	8	uimsbf
for(i=0; i<num_channels_in_section; i++) {		
short_name	7*16	uimsbf
reserved	4	'1111'
major_channel_number	10	uimsbf
minor_channel_number	10	uimsbf
modulation_mode	8	uimsbf
carrier_frequency	32	uimsbf
channel_TSID	16	uimsbf
program_number	16	uimsbf
ETM_location	2	uimsbf
access_controlled	1	bslbf
hidden	1	bslbf
reserved	2	'11'
hide_guide	1	bslbf
reserved	3	'111'
service_type	6	uimsbf
source_id	16	uimsbf
reserved	6	'111111'
descriptors_length	10	uimsbf
for (i=0;i<N;i++) {		
descriptor()		
}		
}		
reserved	6	'111111'
additional_descriptors_length	10	uimsbf
for(j=0; j<N;j++) {		
additional_descriptor()		
}		
CRC_32	32	rpchof
}		

table_id — An 8-bit unsigned integer number that indicates the type of table section being defined here. For the `terrestrial_virtual_channel_table_section()`, the `table_id` shall be 0xC8.

section_syntax_indicator — The `section_syntax_indicator` is a one-bit field which shall be set to ‘1’ for the `terrestrial_virtual_channel_table_section()`.

private_indicator — This 1-bit field shall be set to ‘1’.

section_length — This is a twelve bit field, the first two bits of which shall be ‘00’. It specifies the number of bytes of the section, starting immediately following the `section_length` field, and including the CRC. The value in this field shall not exceed 1021.

transport_stream_id — The 16-bit MPEG-2 Transport Stream ID, as it appears in the Program Association Table (PAT) identified by a PID value of zero for this multiplex. The `transport_stream_id` distinguishes this Terrestrial Virtual Channel Table from others that may be broadcast in different PTCs.

version_number — This 5 bit field is the version number of the Virtual Channel Table. For the current VCT (`current_next_indicator` = 1), the version number shall be incremented by 1 whenever the definition of the current VCT changes. Upon reaching the value 31, it wraps around to 0. For the next VCT (`current_next_indicator` = 0), the version number shall be one unit more than that of the current VCT (also in modulo 32 arithmetic). In any case, the value of the `version_number` shall be identical to that of the corresponding entries in the MGT.

current_next_indicator — A one-bit indicator, which when set to ‘1’ indicates that the Virtual Channel Table sent is currently applicable. When the bit is set to ‘0’, it indicates that the table sent is not yet applicable and shall be the next table to become valid. This standard imposes no requirement that “next” tables (those with `current_next_indicator` set to ‘0’) must be sent. An update to the currently applicable table shall be signaled by incrementing the `version_number` field.

Informative note: It is inadvisable to deliver “next” tables far in advance of their use, because the complexity of the process necessary to make a change to either current *or* next is significantly increased. Transmission of a “next” table may be helpful when the table is so large it requires multiple sections for delivery. For tables small enough to fit into one section, use of “next” tables is deprecated (strongly discouraged).

section_number — This 8 bit field gives the number of this section. The `section_number` of the first section in the Terrestrial Virtual Channel Table shall be 0x00. It shall be incremented by one with each additional section in the Terrestrial Virtual Channel Table.

last_section_number — This 8 bit field specifies the number of the last section (that is, the section with the highest `section_number`) of the complete Terrestrial Virtual Channel Table.

protocol_version — An 8-bit unsigned integer field whose function is to allow, in the future, this table type to carry parameters that may be structured differently than those defined in the current protocol. At present, the only valid value for `protocol_version` is zero. Non-zero values of `protocol_version` may be used by a future version of this standard to indicate structurally different tables.

num_channels_in_section — This 8 bit field specifies the number of virtual channels in this VCT section. The number is limited by the section length.

short_name — The name of the virtual channel, represented as a sequence of one to seven 16-bit code values interpreted in accordance with the UTF-16 representation of Unicode character

data. If the length of the name requires fewer than seven 16-bit code values, this field shall be padded out to seven 16-bit code values using the Unicode NUL character (0x0000). Unicode character data shall conform to The Unicode Standard, Version 3.0 [10]. The UTF-16 representation of Unicode character data is in accordance with that defined by [10], which is identical to that defined by ISO/IEC 10646-1:2000 Annex C [7].

major_channel_number — A 10-bit number that represents the “major” channel number associated with the virtual channel being defined in this iteration of the “for” loop. Each virtual channel shall be associated with a major and a minor channel number. The major channel number, along with the minor channel number, act as the user’s reference number for the virtual channel. The `major_channel_number` shall be between 1 and 99. The value of `major_channel_number` shall be set such that in no case is a `major_channel_number/minor_channel_number` pair duplicated within the TVCT. For `major_channel_number` assignments in the U.S., refer to Annex B.

minor_channel_number — A 10-bit number in the range 0 to 999 that represents the “minor” or “sub”- channel number. This field, together with `major_channel_number`, performs as a two-part channel number, where `minor_channel_number` represents the second or right-hand part of the number. When the `service_type` is analog television, `minor_channel_number` shall be set to 0. Services whose `service_type` is either `ATSC_digital_television` or `ATSC_audio_only` shall use minor numbers between 1 and 99. The value of `minor_channel_number` shall be set such that in no case is a `major_channel_number/minor_channel_number` pair duplicated within the TVCT. For other types of services, such as data broadcasting, valid minor virtual channel numbers are between 1 and 999.

modulation_mode — An 8-bit unsigned integer number that indicates the modulation mode for the transmitted carrier associated with this virtual channel. Values of `modulation_mode` shall be as defined in Table 6.5. For digital signals, the standard values for modulation mode (values below 0x80) indicate transport framing structure, channel coding, interleaving, channel modulation, forward error correction, symbol rate, and other transmission-related parameters, by means of a reference to an appropriate standard. The `modulation_mode` field shall be disregarded for inactive channels.

Table 6.5 Modulation Modes

modulation_mode	Meaning
0x00	[Reserved]
0x01	Analog — The virtual channel is modulated using standard analog methods for analog television.
0x02	SCTE_mode_1 — The virtual channel has a symbol rate of 5.057 Msps, transmitted in accordance with <i>Digital Video Transmission Standard for Cable Television</i> , [20] (Mode 1). Typically, mode 1 will be used for 64-QAM.
0x03	SCTE_mode_2 — The virtual channel has a symbol rate of 5.361 Msps, transmitted in accordance with <i>Digital Video Transmission Standard for Cable Television</i> , [20] (Mode 2). Typically, mode 2 will be used for 256-QAM.
0x04	ATSC (8 VSB) — The virtual channel uses the 8-VSB modulation method conforming to the <i>ATSC Digital Television Standard A/53D</i> [1], Annex D.
0x05	ATSC (16 VSB) — The virtual channel uses the 16-VSB modulation method conforming to the <i>ATSC Digital Television Standard A/53D</i> [1], Annex D.
0x06-0x7F	[Reserved for future use by ATSC]
0x80-0xFF	[User Private]

carrier_frequency — The recommended value for these 32 bits is zero. Use of this field to identify carrier frequency is allowed, but is deprecated. After January 1, 2010, these 32 bits shall be set to zero.

Informative note: The receiver is expected to record the TSID value as indicated in the PAT of each digital Transport Stream and make note of the frequency used to tune it. In the case of an analog waveform, the analog TSID value carried in the VBI is recorded. The value of channel_TSID given in the VCT is matched against TSID values to form the association between PSIP data and transmitted content.

channel_TSID — A 16-bit unsigned integer field in the range 0x0000 to 0xFFFF that represents the MPEG-2 Transport Stream ID associated with the Transport Stream carrying the MPEG-2 program referenced by this virtual channel⁷. For inactive channels, channel_TSID shall represent the ID of the Transport Stream that will carry the service when it becomes active. The receiver is expected to use the channel_TSID to verify that any received Transport Stream is actually the desired multiplex. For analog channels (service_type 0x01), channel_TSID shall indicate the value of the analog TSID included in the VBI of the NTSC signal. Refer to Annex D Section 9 for a discussion on use of the analog TSID.

program_number — A 16-bit unsigned integer number that associates the virtual channel being defined here with the MPEG-2 PROGRAM ASSOCIATION and TS PROGRAM MAP tables. For virtual channels representing analog services, a value of 0xFFFF shall be specified for program_number. For inactive channels (those not currently present in the

⁷ *Informative note:* A registration authority for each region assigns TSID values, for both analog and digital signals. Contact ATSC for the name of the registration authority applicable to a specific region of interest.

Transport Stream), `program_number` shall be set to zero. This number shall **not** be interpreted as pointing to a Program Map Table entry.

ETM_location — This 2-bit field specifies the existence and the location of an Extended Text Message (ETM) and shall be as defined in Table 6.6.

Table 6.6 ETM Location

ETM_location	Meaning
'00'	No ETM
'01'	ETM located in the PTC carrying this PSIP
'02'	ETM located in the PTC specified by the <code>channel_TSID</code>
'03'	[Reserved for future ATSC use]

access_controlled — A 1-bit Boolean flag that indicates, when set, that the events associated with this virtual channel may be access controlled. When the flag is set to 0, event access is not restricted.

hidden — A 1-bit Boolean flag that indicates, when set, that the virtual channel is not accessed by the user by direct entry of the virtual channel number. Hidden virtual channels are skipped when the user is channel surfing, and appear as if undefined, if accessed by direct channel entry. Typical applications for hidden channels are test signals and NVOD services. Whether a hidden channel and its events may appear in EPG displays depends on the state of the `hide_guide` bit.

hide_guide — A Boolean flag that indicates, when set to 0 for a hidden channel, that the virtual channel and its events may appear in EPG displays. This bit shall be ignored for channels which do not have the `hidden` bit set, so that non-hidden channels and their events may always be included in EPG displays regardless of the state of the `hide_guide` bit. Typical applications for hidden channels with the `hide_guide` bit set to 1 are test signals and services accessible through application-level pointers.

service_type — A 6-bit enumerated type field that shall identify the type of service carried in this virtual channel as defined in Table 6.7.

Table 6.7 Service Types

service_type	Meaning
0x00	[Reserved]
0x01	<code>analog_television</code> — The virtual channel carries analog television programming
0x02	<code>ATSC_digital_television</code> — The virtual channel carries television programming (audio, video and optional associated data) conforming to ATSC standards
0x03	<code>ATSC_audio</code> — The virtual channel carries audio programming (audio service and optional associated data) conforming to ATSC standards.
0x04	<code>ATSC_data_only_service</code> — The virtual channel carries a data service conforming to ATSC standards, but no video of <code>stream_type</code> 0x02 or audio of <code>stream_type</code> 0x81.
0x05-0x3F	[Reserved for future ATSC use]

source_id — A 16-bit unsigned integer number that identifies the programming source associated with the virtual channel. In this context, a source is one specific source of video, text, data, or

audio programming. Source ID value zero is reserved. Source ID values in the range 0x0001 to 0x0FFF shall be unique within the Transport Stream that carries the VCT, while values 0x1000 to 0xFFFF shall be unique at the regional level. Values for `source_ids` 0x1000 and above shall be issued and administered by a Registration Authority designated by the ATSC.

descriptors_length — Total length (in bytes) of the descriptors for this virtual channel that follows.

descriptor() — Zero or more descriptors, as appropriate, may be included.

additional_descriptors_length — Total length (in bytes) of the VCT descriptor list that follows.

CRC_32 — This is a 32-bit field that contains the CRC value that ensures a zero output from the registers in the decoder defined in Annex A of ISO/IEC 13818-1 “MPEG-2 Systems” [8] after processing the entire Terrestrial Virtual Channel Table section.

An *inactive channel* is defined as a channel that has program guide data available, but the channel is not currently on the air. Inactive channels are represented as hidden channels with the `hide_guide` bit set to 0. The Transport Stream shall not carry a Program Map Table representing an inactive channel.

For inactive channels, the `short_name`, `major_channel_number`, and `minor_channel_number` fields reflect the name and channel number of the inactive channel, and may be used in construction of the program guide. The `source_id` for inactive channels is used, as it is for active channels, to link the virtual channel to the program guide data. The `ETM_location` indicates, as it does for active channels, the location of text related to the virtual channel. The `service_type` field and attribute flag `access_controlled` reflect the characteristics of the channel that will be valid when it is active.

6.3.2 Cable Virtual Channel Table

The Cable Virtual Channel Table is carried in private sections with table ID 0xC9, and obeys the syntax and semantics given in Section 4. The following constraints apply to the Transport Stream packets carrying the VCT sections:

- `PID` for Cable VCT shall have the value 0x1FFB (`base_PID`)
- `transport_scrambling_control` bits shall have the value ‘00’
- `adaptation_field_control` bits shall have the value ‘01’

The Cable Virtual Channel Table may be present in a terrestrial broadcast multiplex when a broadcaster has coordinated consistent channel labeling/numbering with all local cable operators carrying that multiplex, and different channel labeling and/or numbering between cable and terrestrial broadcast is desired. When both CVCT and TVCT are present in the multiplex, receiving devices are expected to use the TVCT to navigate services received via terrestrial broadcast and the CVCT to navigate services received via cable.

The bit stream syntax for the Cable Virtual Channel Table shall be as shown in Table 6.8. The semantics for the CVCT are the same as the TVCT except for those fields explicitly defined below.

table_id — An 8-bit unsigned integer number that indicates the type of table section being defined here. For the `cable_virtual_channel_table_section`, the `table_id` shall be 0xC9.

major_channel_number, **minor_channel_number** — These two 10-bit fields represent either a two-part or a one-part virtual channel number associated with the virtual channel being defined in

this iteration of the “for” loop⁸. The one- or two-part number acts as the user’s reference number for the virtual channel. Some channels in the CVCT may be represented with a one-part number while others are represented with two-part numbers. Channel number values shall be set such that in no case is a `major_channel_number/minor_channel_number` pair duplicated within the CVCT.

To specify a two-part channel number, both the `major_channel_number` and the `minor_channel_number` fields shall be below 1000. To specify a one-part channel number, the six most significant bits of `major_channel_number` shall be ‘11 1111’. Values and combinations of `major_channel_number` and `minor_channel_number` falling outside these ranges are reserved. The one-part channel number is a 14-bit quantity that shall be computed by the following formula, represented in C syntax:

$$\text{one_part_number} = (\text{major_channel_number} \& 0x00F) \ll 10 + \text{minor_channel_number}$$

⁸ Note that these semantics permit these two forms of virtual channel numbers, in separate iterations of the “for” loop, to identify the same set of program elements.

Table 6.8 Bit Stream Syntax for the Cable Virtual Channel Table

Syntax	No. of Bits	Format
cable_virtual_channel_table_section () {		
table_id	8	0xC9
section_syntax_indicator	1	'1'
private_indicator	1	'1'
reserved	2	'11'
section_length	12	uimbsbf
transport_stream_id	16	uimbsbf
reserved	2	'11'
version_number	5	uimbsbf
current_next_indicator	1	bslbf
section_number	8	uimbsbf
last_section_number	8	uimbsbf
protocol_version	8	uimbsbf
num_channels_in_section	8	uimbsbf
for(i=0; i<num_channels_in_section;i++) {		
short_name	7*16	uimbsbf
reserved	4	'1111'
major_channel_number	10	uimbsbf
minor_channel_number	10	uimbsbf
modulation mode	8	uimbsbf
carrier_frequency	32	uimbsbf
channel_TSID	16	uimbsbf
program_number	16	uimbsbf
ETM_location	2	uimbsbf
access_controlled	1	bslbf
hidden	1	bslbf
path_select	1	bslbf
out_of_band	1	bslbf
hide_guide	1	bslbf
reserved	3	'111'
service_type	6	uimbsbf
source_id	16	uimbsbf
reserved	6	'111111'
descriptors_length	10	uimbsbf
for (i=0;i<N;i++) {		
descriptor()		
}		
}		
reserved	6	'111111'
additional_descriptors_length	10	uimbsbf
for(j=0; j<N;j++) {		
additional_descriptor()		
}		
CRC_32	32	rpchbf
}		

path_select — A 1-bit field that associates the virtual channel with a transmission path. For the cable transmission medium, path_select identifies which of two physical input cables carries the Transport Stream associated with this virtual channel.. When the channel is inactive,

`path_select` shall reflect the characteristics of the channel that will be valid when it is again active, as defined in table 6.9.

Table 6.9 Path Select

<code>path_select</code>	Meaning
0	path 1
1	path 2

out_of_band — A Boolean flag that indicates, when set, that the virtual channel defined in this iteration of the “for” loop is carried on the cable on the out-of-band physical transmission channel. When clear, the virtual channel is carried within a tuned multiplex. When the channel is inactive, `out_of_band` shall reflect the characteristics of the channel that will be valid when it is again active.

source_id — A 16-bit unsigned integer number that identifies the programming source associated with the virtual channel. In this context, a source is one specific source of video, text, data, or audio programming. Source ID value zero is reserved to indicate that the programming source is not identified. Source ID values in the range 0x0001 to 0x0FFF shall be unique within the Transport Stream that carries the VCT, while values 0x1000 to 0xFFFF shall be unique at the regional level. Values for `source_ids` 0x1000 and above shall be issued and administered by a Registration Authority designated by the ATSC.

6.4 Rating Region Table (RRT)

The Rating Region Table (RRT) carries rating information for multiple geographical regions. Each RRT instance, identified by `rating_region` (the 8 least significant bits of `table_id_extension`), conveys the rating system information for one specific region. The size of each RRT instance shall not be more than 1024 bytes (including section header and trailer), and it shall be carried by only one MPEG-2 private section.

An RRT defining the rating system for a given region shall be included in the TS if any `content_advisory_descriptor` in use refers to that region, except if the RRT corresponding to that `rating_region` is fully defined in standards for that region.

The following constraints apply to the Transport Stream packets carrying the RRT sections.

- PID shall have the value 0x1FFB (base_PID)
- `transport_scrambling_control` bits shall have the value ‘00’
- `adaptation_field_control` bits shall have the value ‘01’

The bit stream syntax for the Rating Region Table shall be as shown in Table 6.10.

Table 6.10 Bit Stream Syntax for the Rating Region Table

Syntax	No. of Bits	Format
rating_region_table_section () {		
table_id	8	0xCA
section_syntax_indicator	1	'1'
private_indicator	1	'1'
reserved	2	'11'
section_length	12	uimsbf
table_id_extension {		
reserved	8	0xFF
rating_region	8	uimsbf
}		
reserved	2	'11'
version_number	5	uimsbf
current_next_indicator	1	'1'
section_number	8	uimsbf
last_section_number	8	uimsbf
protocol_version	8	uimsbf
rating_region_name_length	8	uimsbf
rating_region_name_text()	var	
dimensions_defined	8	uimsbf
for(i=0; i<dimensions_defined;i++) {		
dimension_name_length	8	uimsbf
dimension_name_text()	var	
reserved	3	'111'
graduated_scale	1	bslbf
values_defined	4	uimsbf
for (j=0;j<values_defined;j++) {		
abbrev_rating_value_length	8	uimsbf
abbrev_rating_value_text()	var	
rating_value_length	8	uimsbf
rating_value_text()	var	
}		
}		
reserved	6	'111111'
descriptors_length	10	uimsbf
for (i=0;i<N;i++) {		
descriptor()		
}		
CRC_32	32	rpchof
}		

table_id — This is an 8-bit field, which shall be set to 0xCA, identifying this table as the Rating Region Table (RRT).

section_syntax_indicator — This 1-bit field shall be set to '1'. It denotes that the section follows the generic section syntax beyond the section length field.

private_indicator — This 1-bit field shall be set to '1'.

section_length — 12-bit field specifying the number of remaining bytes in this section immediately following the `section_length` field up to the end of the section. The value of the `section_length` shall be no larger than 1021.

rating_region — An 8-bit unsigned integer number that defines the rating region to be associated with the text in this `rating_region_table_section()`. The value of this field is the identifier of this rating region, and thus this field may be used by the other tables (e.g., MGT) for referring to a specific rating region table. A `rating_region` value of 0x00 shall not be used. This field shall only contain values in the range 0x01-0xFF that have been defined by the ATSC. Contact ATSC for current assignment of values for `rating_region`.

version_number — This 5-bit field is the version number of the Rating Region table identified by combination of the fields `table_id` and `table_id_extension`. The version number shall be incremented by 1 modulo 32 when any field in this instance of the Rating Region Table changes. The value of this field shall be the same as that of the corresponding entry in MGT.

current_next_indicator — This 1-bit indicator is always set to '1'.

section_number — The value of this 8-bit field shall always be 0x00.

last_section_number — The value of this 8-bit field shall always be 0x00.

protocol_version — The value of this 8-bit field shall always be 0x00.

rating_region_name_length — An 8-bit unsigned integer number that defines the total length (in bytes) of the `rating_region_name_text()` field to follow.

rating_region_name_text() — A data structure containing a multiple string structure which represents the rating region name, e.g., "U.S. (50 states + possessions)", associated with the value given by `rating_region`. Text strings are formatted according to the rules outlined in Section 6.12. The display string for the rating region name shall be limited to 32 characters or less.

dimensions_defined — This 8-bit field (1-255) specifies the number of dimensions defined in this `rating_region_table_section()`.

dimension_name_length — An 8-bit unsigned integer number that defines the total length in bytes of the `dimension_name_text()` field to follow.

dimension_name_text() — A data structure containing a multiple string structure which represents the dimension name being described in the loop. One dimension in the U.S. rating region, for example, is used to describe the MPAA list. The dimension name for such a case may be defined as "MPAA". Text strings are formatted according to the rules outlined in Section 6.12. The dimension name display string shall be limited to 20 characters or less.

graduated_scale — This 1-bit flag indicates whether or not the rating values in this dimension represent a graduated scale; i.e., higher rating values represent increasing levels of rated content within the dimension. Value 1 means yes, while value 0 means no.

values_defined — This 4-bit field (1–15) specifies the number of values defined for this particular dimension.

abbrev_rating_value_length — An 8-bit unsigned integer number that defines the total length (in bytes) of the `abbrev_rating_value_text()` field to follow.

abbrev_rating_value_text() — A data structure containing a multiple string structure which represents the abbreviated name for one particular rating value. The abbreviated name for rating value 0 shall be set to a null string; i.e., "". Text strings are formatted according to the

rules outlined in Section 6.12. The abbreviated value display string shall be limited to 8 characters or less.

rating_value_length — An 8-bit unsigned integer number that defines the total length (in bytes) of the rating_value_text() field to follow.

rating_value_text() — A data structure containing a multiple string structure which represents the full name for one particular rating value. The full name for rating value 0 shall be set to a null string; i.e., “”. Text strings are formatted according to the rules outlined in Section 6.12. The rating value display string shall be limited to 150 characters or less.

descriptors_length — Length (in bytes) of all of the descriptors that follow this field.

descriptor() — Zero or more descriptors, as appropriate, may be included.

CRC_32 — This is a 32-bit field that contains the CRC value that ensures a zero output from the registers in the decoder defined in Annex A of ISO/IEC 13818-1 “MPEG-2 Systems” [8] after processing the entire Rating Region Table section.

6.5 Event Information Table (EIT)

The Event Information Table (EIT) contains information⁹ (titles, start times, etc.) for events on defined virtual channels. An event is, in most cases, a typical TV program. The EIT shall be used to provide information for virtual channels of service_type 0x01, 0x02, or 0x03 (Table 6.7 defines service_type). For data-only services (those identified with service_type 0x04 in the VCT), the EIT shall not be used. Up to 128 EITs may be transmitted and each of them is referred to as EIT-k, with k = 0, 1, ... 127.

Each EIT-k can have multiple instances, each of which contains information for one virtual channel, and each of which is identified by the combination of table_id and source_id. Each EIT-k instance may be segmented into as many as 256 sections. One section may contain information for several events, but the information for one event shall not be segmented and put into two or more sections. Thus the first field after protocol_version for each section shall be num_events_in_section.

PSIP supports up to 128 EITs, each of which provides the event information for a certain time span. For terrestrial broadcast, at least the first four EITs shall be included in the Transport Stream. Any event programmed for a time interval that extends over one or more EITs shall be described in each of these EITs, with the same event_id. For instance, an event that starts at 17:30 UTC and lasts until 19:30 UTC will appear in two EITs with the same event_id, the EIT covering 15:00-18:00 (UTC) as well as the EIT covering 18:00-21:00 (UTC). For a particular virtual channel, an event_id identifies uniquely each of the events programmed for the 3-hour interval of an EIT.

Each virtual channel defined in the VCT shall have a corresponding instance of EIT-k, unless the virtual channel belongs to a group sharing the same source_id. Virtual channels sharing a source_id appear in applications such as NVOD. In such a case, the entire group will have a

⁹ Note that the FCC said (in relevant part) in paragraph 152 of the FCC R&O on the Second Periodic Review of the Commissions Rules and Policies Affecting the Conversion to Digital Television (FCC 04-192): “We expect broadcasters to populate the required tables and descriptors with the proper information to help receivers assemble functioning guides. ... These EITs should be populated with the correct information, so that the user knows what programs are on for this [9 to] 12 hour period.”

unique instance of EIT-k identified precisely by the `source_id`. If a virtual channel has no event in the time span covered by EIT-k, its corresponding EIT instance shall have only one section, and the field `num_events_in_section` shall be set to zero.

Events shall be in the order of their starting times; i.e., the start time of the first event shall be ahead of that of the second event, and the start time of the last event in section one shall be equal or less than that of the first event in section two with the equality holding only when both events are the same. The contents of the fields and the descriptors in each events descriptor loop shall be accurate representations of the known information about each event at the time the event instance is created and shall be updated if more accurate information becomes available.

For NVOD services, event entries in the EIT correspond to events scheduled in the virtual channel that carry the `time_shifted_descriptor` (the reference virtual channel). However, an NVOD event shall be listed in applicable EITs even when the NVOD event has finished in the reference virtual channel as long as the NVOD event remains on the air as a time shifted service in complementary virtual channels. Hence, an EIT may contain, in some cases, an expired event describing NVOD services.

The Event Information Table is carried in private sections with table ID 0xCB, and obeys the syntax and semantics given in Section 4. The following constraints apply to the Transport Stream packets carrying the EIT sections:

- PID for EIT-k shall have the same value as specified in the MGT, and shall be unique among the collection of `table_type_PID` values listed in the MGT.
- `transport_scrambling_control` bits shall have the value '00'.
- `adaptation_field_control` bits shall have the value '01'.

The bit stream syntax for the Event Information Table shall be as shown in Table 6.11.

Table 6.11 Bit Stream Syntax for the Event Information Table

Syntax	No. of Bits	Format
event_information_table_section () {		
table_id	8	0xCB
section_syntax_indicator	1	'1'
private_indicator	1	'1'
reserved	2	'11'
section_length	12	uimsbf
source_id	16	uimsbf
reserved	2	'11'
version_number	5	uimsbf
current_next_indicator	1	'1'
section_number	8	uimsbf
last_section_number	8	uimsbf
protocol_version	8	uimsbf
num_events_in_section	8	uimsbf
for (j = 0; j < num_events_in_section; j++) {		
reserved	2	'11'
event_id	14	uimsbf
start_time	32	uimsbf
reserved	2	'11'
ETM_location	2	uimsbf
length_in_seconds	20	uimsbf
title_length	8	uimsbf
title_text()	var	
reserved	4	'1111'
descriptors_length	12	
for (i=0; i < N; i++) {		
descriptor()		
}		
}		
CRC_32	32	rpchof
}		

table_id — This is an 8-bit field which shall be set to 0xCB, identifying this section as belonging to the Event Information Table.

section_syntax_indicator — This 1-bit field shall be set to '1'. It denotes that the section follows the generic section syntax beyond the section length field.

private_indicator — This 1-bit field shall be set to '1'.

section_length — 12-bit field specifying the number of remaining bytes in this section immediately following the section_length field up to the end of the section, including the CRC_32 field. The value of this field shall not exceed 4093.

source_id — This 16-bit field specifies the source_id of the virtual channel carrying the events described in this section.

version_number — This 5-bit field is the version number of EIT-i. The version number shall be incremented by 1 modulo 32 when any field in the EIT-i changes. Note that the version_number for EIT-i has no relation with that for EIT-j when j is not equal to i. The value of this field shall be identical to that of the corresponding entry in the MGT.

current_next_indicator — This 1-bit indicator is always set to ‘1’ for EIT sections; the EIT sent is always currently applicable.

section_number — This 8-bit field gives the number of this section.

last_section_number — This 8-bit field specifies the number of the last section.

protocol_version — An 8-bit unsigned integer field whose function is to allow, in the future, this table type to carry parameters that may be structured differently than those defined in the current protocol. At present, the only valid value for `protocol_version` is zero. Non-zero values of `protocol_version` may be used by a future version of this standard to indicate structurally different tables.

num_events_in_section — Indicates the number of events in this EIT section. Value 0 indicates no events defined in this section.

event_id — This field specifies the identification number of the event described. This number will serve as a part of the event `ETM_id` (identifier for event extended text message).

start_time — A 32-bit unsigned integer quantity representing the start time of this event as the number of GPS seconds since 00:00:00 UTC, January 6, 1980. In any virtual channel, the `start_time` value of an event shall not be less than the end time of the preceding event where the end time of an event is defined to be equal to that event's `start_time` value plus that event's `length_in_seconds` value.

ETM_location — This 2-bit field specifies the existence and the location of an Extended Text Message (ETM). The value of this field shall be as defined in Table 6.12.

Table 6.12 ETM Location

ETM_location	Meaning
0x0	No ETM
0x1	ETM located in the PTC carrying this PSIP
0x2	ETM located in the PTC carrying this event
0x3	[Reserved for future ATSC use]

length_in_seconds — Duration of this event in seconds.

title_length — This field specifies the length (in bytes) of the `title_text()`. Value 0 means that no title exists for this event.

title_text() — The event title in the format of a multiple string structure (see Section 6.12).

descriptors_length — Total length (in bytes) of the event descriptor list that follows.

descriptor() — Zero or more descriptors may be included in the EIT in an iteration of the event “for” loop. The types of descriptors defined for use in the EIT include the `content_advisory_descriptor()`, the `caption_service_descriptor()` and the `AC-3 audio_stream_descriptor()`.

CRC_32 — This is a 32-bit field that contains the CRC value that ensures a zero output from the registers in the decoder defined in Annex A of ISO-13818-1 “MPEG-2 Systems” [8] after processing the entire Event Information Table section.

6.6 Extended Text Table (ETT)

The Extended Text Table (ETT) contains Extended Text Message (ETM) streams, which are optional and are used to provide detailed descriptions of virtual channels (channel ETM) and events (event ETM). An ETM is a multiple string data structure (see Section 6.12), and thus, it may represent a description in several different languages (each string corresponding to one language). If necessary, the description may be truncated to fit allocated display space.

The Extended Text Message is carried in private sections with table ID 0xCC and obeys the syntax and semantics given in Section 4. Each description is distinguished by its unique 32-bit ETM_id immediately after the field protocol_version. This allows the receiver to search for a single description quickly without having to parse the payload of a large table.

The ETT section for a virtual channel or an event is carried in the home physical transmission channel (the physical transmission channel carrying that virtual channel or event) with PID specified by the field table_type_PID in corresponding entries in the MGT. This specific PID is exclusively reserved for the ETT stream.

The following constraints apply to the Transport Stream packets carrying the ETT sections.

- PID for ETT shall have the same value as the field table_type_PID in corresponding entries in the MGT, and shall be unique among the collection of table_type_PID values listed in the MGT.
- transport_scrambling_control bits shall have the value '00'
- adaptation_field_control bits shall have the value '01'

The bit stream syntax for the Extended Text Table shall be as shown in Table 6.13.

Table 6.13 Bit Stream Syntax for the Extended Text Table

Syntax	No. of Bits	Format
extended_text_table_section () {		
table_id	8	0xCC
section_syntax_indicator	1	'1'
private_indicator	1	'1'
reserved	2	'11'
section_length	12	uimsbf
ETT_table_id_extension	16	0x0000
reserved	2	'11'
version_number	5	uimsbf
current_next_indicator	1	'1'
section_number	8	0x00
last_section_number	8	0x00
protocol_version	8	uimsbf
ETM_id	32	uimsbf
extended_text_message ()	var	
CRC_32	32	rpchof
}		

table_id — Identifies this section as belonging to an Extended Text Table. (0xCC).

section_syntax_indicator — This 1-bit field shall be set to '1'. It denotes that the section follows the generic section syntax beyond the section length field.

private_indicator — This 1-bit field shall be set to ‘1’.

section_length — 12-bit field specifying the number of remaining bytes in the section immediately following the section_length field up to the end of the section. The value of the section_length shall be no larger than 4093.

ETT_table_id_extension — A 16-bit unsigned integer value that serves to establish the uniqueness of each ETT instance when the tables appear in transport stream packets with common PID values. The ETT’s table_ID_extension shall be set to a value such that separate ETT instances appearing in transport stream packets with common PID values have a unique ETT_table_ID_extension value.¹⁰

version_number — For the channel ETT, this 5-bit field indicates the version number of the channel ETT. The version number shall be incremented by 1 modulo 32 when any ETM in the channel ETT changes. For event ETT, this 5-bit field indicates the version number of event ETT-i, where i, as in the EIT case, is the index of time span. The version number shall be incremented by 1 modulo 32 when any ETM in the event ETT-i changes. Note that the version_number for event ETT-i has no relation with that for event ETT-j when j is not equal to i. The value of this field shall be identical to that of the corresponding entry in the MGT.

current_next_indicator — This 1-bit indicator is always set to ‘1’ for ETT sections; the ETT sent is always currently applicable.

section_number — The value of this 8-bit field shall always be 0x00 (this table is only one section long).

last_section_number — The value of this 8-bit field shall always be 0x00.

protocol_version — An 8-bit unsigned integer field whose function is to allow, in the future, this table type to carry parameters that may be structured differently than those defined in the current protocol. At present, the only valid value for protocol_version is zero. Non-zero values of protocol_version may be used by a future version of this standard to indicate structurally different tables.

ETM_id — Unique 32-bit identifier of this extended text message. This identifier is assigned by the rule shown in Table 6.14.

Table 6.14 ETM ID

	MSB				LSB			
Bit	31	...	16	15	...	2	‘10’	
channel ETM_id	source_id			0	...	0	‘00’	
event ETM_id	source_id			event_id			‘10’	

extended_text_message() — The extended text message in the format of a multiple string structure (see Section 6.12).

CRC_32 — This is a 32-bit field that contains the CRC value that ensures a zero output from the registers in the decoder defined in Annex A of ISO-13818-1 “MPEG-2 Systems” [8] after processing the entire Transport Stream ETT section.

¹⁰ Broadcasters in Korea are advised that some deployed receivers may not operate correctly with a non-zero value for this field.

6.7 Directed Channel Change Table (DCCT)

The optional Directed Channel Change Table provides definitions of virtual channel change requests. The table permits the broadcaster to indicate when the viewing experience can be enhanced by a change of virtual channels within or between physical channels. The requested channel change may be unconditional or may be based upon geographic, demographic, or categorical broadcast programming content selection criteria which may be specified and provided by the viewer to his/her “DCC capable DTV reference receiver¹¹” (hereinafter DCCRR) through a menu setup type of procedure or through direct input. In the event that the viewer does not provide some of the Directed Channel Change Table setup selection criteria to the DCCRR, that portion of a DCC request shall be handled by the DCCRR in accordance with the specific rules defined in this specification. If Directed Channel Change is not supported by a DTV receiver there is no visible impact on the main broadcast program perceived by the viewer.

Several different DCCT instances may be present in the Transport Stream at any given time, each providing channel change information pertaining to one or more virtual channels.

Contained within the DCCT is a “for loop” structure that permits the ability to specify zero or more “tests” to be performed to determine whether or not a channel change may be effected. The tests, summarized in Table 6.17, may include requests such as determination if a viewer’s DTV is located within a particular postal code region, whether the viewer is a member of a particular demographic group, or whether a program’s content rating value results in a viewing block. Other tests are possible, as described within this standard. Additionally, different types of tests may be combined within one or more instances of a DCCT to allow logical “ORing” of channel change eligibility criteria.

A “DCC request” corresponds to one iteration of the `dcc_test_count` “for” loop. If evaluation of terms for a number of DCC requests given in one DCCT section indicates a true result for more than one request, the DCCRR is expected to take action on the first true request encountered. The term “DCC event” as used in this standard, shall refer to a channel change resulting from a DCC request.

The following constraints apply to the Transport Stream packet(s) carrying the DCCT:

- PID for DCCT shall have the value 0x1FFB (base_PID)
- `transport_scrambling_control` bits shall have the value ‘00’
- `adaptation_field_control` bits shall have the value ‘01’

The Directed Channel Change Table is carried in MPEG-2 private sections with table ID 0xD3, and obeys the syntax and semantics given in Section 4. The bit stream syntax for the Directed Channel Change Table section shall be as shown in Table 6.15.

¹¹ Note: Receiver implementation is optional. For receiving devices that implement DCC functionality, the stated requirements for the DCCRR apply.

Table 6.15 Bit Stream Syntax for the Directed Channel Change Table

Syntax	No. of Bits	Format
directed_channel_change_table_section () {		
table_id	8	0xD3
section_syntax_indicator	1	'1'
private_indicator	1	'1'
reserved	2	'11'
section_length	12	uimsbf
dcc_subtype	8	0x00
dcc_id	8	uimsbf
reserved	2	'11'
version_number	5	uimsbf
current_next_indicator	1	'1'
section_number	8	0x00
last_section_number	8	0x00
protocol_version	8	uimsbf
dcc_test_count	8	uimsbf
for (i = 0; i < dcc_test_count; i++) {		
dcc_context	1	uimsbf
reserved	3	'111'
dcc_from_major_channel_number	10	uimsbf
dcc_from_minor_channel_number	10	uimsbf
reserved	4	'1111'
dcc_to_major_channel_number	10	uimsbf
dcc_to_minor_channel_number	10	uimsbf
dcc_start_time	32	uimsbf
dcc_end_time	32	uimsbf
dcc_term_count	8	uimsbf
for (j = 0; j < dcc_term_count; j++) {		
dcc_selection_type	8	uimsbf
dcc_selection_id	64	uimsbf
reserved	6	'111111'
dcc_term_descriptors_length	10	uimsbf
for (k = 0; k < N; k++) {		
dcc_term_descriptor()		
}		
}		
reserved	6	'111111'
dcc_test_descriptors_length	10	uimsbf
for (j = 0; j < N; j++) {		
dcc_test_descriptor()		
}		
}		
reserved	6	'111111'
dcc_additional_descriptors_length	10	uimsbf
for (i = 0; i < N; i++) {		
dcc_additional_descriptor()		
}		
CRC_32	32	rpchof
}		

table_id — This is an 8-bit field, which shall be set to 0xD3, identifying this table section as a Directed Channel Change Table section.

section_syntax_indicator — This 1-bit field shall be set to ‘1’. It denotes that the section follows the MPEG-2 long-form section syntax beyond the section length field.

private_indicator — This 1-bit field shall be set to ‘1’.

section_length — A 12-bit field specifying the number of remaining bytes in this section immediately following the section_length field up to the end of the section. The value of this field shall not exceed 4093.

dcc_subtype — An 8-bit unsigned integer field that indicates the type of Directed Channel Change Table to follow. In the current specification only one type of DCC is defined, so this field shall be set to 0x00. Implementers are cautioned that dcc_subtype may be non-zero in a future version of this standard.

dcc_id — An 8-bit unsigned integer field that distinguishes different instances of transmitted DCC Table sections. The dcc_id shall be set so that no two currently active transmitted DCC Table sections are identified with the same value.

version_number — This 5-bit field is the version number of the DCC Table identified by the combination of fields dcc_subtype and dcc_id. The version number shall be incremented by 1 modulo 32 when any field in this instance of the DCC Table changes. In any case, the value of the version_number shall be identical to that of the corresponding entry in the MGT.

current_next_indicator — This 1-bit indicator is always set to ‘1’ for a DCCT section; the DCCT sent is always currently applicable.

section_number — The value of this 8-bit field shall always be 0x00 (this table may be at most only one section long).

last_section_number — The value of this 8-bit field shall always be 0x00.

protocol_version — An 8-bit unsigned integer field whose function is to allow, in the future, this table type to carry parameters that may be structured differently than those defined in the current protocol. At present, the only valid value for protocol_version is 0x00. Non-zero values of protocol_version may be used by a future version of this standard to indicate structurally different tables.

dcc_test_count — An 8-bit unsigned integer that specifies the number of channel change tests that will be defined by this DCC Table section. This outer loop associates a DCC request with each indicated virtual channel. A value of 0x00 for dcc_test_count indicates that the table section does not include channel change tests. A zero value may be used for a DCC Table section that carries descriptors in the dcc_additional_descriptors loop.

dcc_context — This 1-bit indicator indicates how a Directed Channel Change made in response to this test is to be handled by the DCCRR in the context of navigation and channel number display. Table 6.16 specifies requirements for operation in the two different specified modes. The dcc_context parameter identifies this DCC directive as being one of two types, either a Temporary Retune or a Channel Redirect.

“DCC From Channel Number” is defined to be the combination of dcc_from_major_channel_number and dcc_from_minor_channel_number. “DCC To Channel Number” is defined to be the combination of dcc_to_major_channel_number and dcc_to_minor_channel_number.

Table 6.16 DCC Context

dcc_context	Name and Function	Channel Number Displayed	New DCCs Accepted
0	Temporary Retune — acquire the virtual channel indicated in DCC To Channel Number and stay there until user changes channel, end time is reached, or DCC is canceled by a Return to Original Channel.	Original channel number: DCC From Channel Number	No (except to signal return to original channel)
1	Channel Redirect — tune to the virtual channel indicated in DCC To Channel Number	Actual channel number: DCC To Channel Number	Yes

6.7.1 Temporary Retune DCC

For a Temporary Retune DCC event, the displayed channel number shall stay constant (at DCC From Channel Number) to prevent confusion among viewers when it is desired to temporarily move them to an alternate program channel in a seamless manner. The DCCRR shall stay tuned to the DCC To Channel Number until one of the following events occurs:

1. The user manually changes channels; or
2. The `dcc_end_time` is reached; or
3. A DCCT is received containing a test in which:
 - a. The DCC From Channel Number matches the original DCC From Channel Number; and
 - b. The DCC To Channel Number matches the original DCC To Channel Number; and
 - c. All the terms evaluate True; and
 - d. One of the terms is Return to Original Channel (`dcc_selection_type = 0x0F`).

If the `dcc_end_time` is reached or a DCCT is received containing a test that matches the conditions in #3, the DCCRR shall immediately retune to the original channel number (DCC From Channel Number).

While tuned to the DCC To Channel Number in response to a Temporary Retune DCC event, the DCCRR shall not respond to DCC directives other than the type described in #3 above. If the user manually changes channels while so tuned, the state of the DCCRR shall be reset and the newly tuned channel shall be considered to be the "from" virtual channel.

The `hide_guide` bit and the `hidden` bit found within the VCT should both be set to 1 for the DCC To Channel Numbers in Temporary Retune DCC events to prevent those channels from appearing in EPG displays.

6.7.2 Channel Redirect DCC

Processing a Channel Redirect DCC event in the DCCRR simply involves a channel change—exactly as if it had been initiated manually by the viewer. Therefore the displayed channel number reflects the actual tuned virtual channel, the `dcc_end_time` in the DCC request shall not be processed, and the DCCRR shall be ready to process further DCC requests.

dcc_from_major_channel_number — A 10-bit number in the range of 1 to 999 that represents the “major” channel number, as defined in Section 6.3.1 Terrestrial Virtual Channel Table or 6.3.2 Cable Virtual Channel Table.

dcc_from_minor_channel_number — A 10-bit number in the range of 1 to 999 that represents the “minor” virtual channel number, as defined in Section 6.3.1 Terrestrial Virtual Channel Table or 6.3.2 Cable Virtual Channel Table.

The DCC From Channel Number defined by the combination of these major and minor channel numbers shall identify a virtual channel that is currently defined in the VCT. This virtual channel may have the “hidden” attribute set.

dcc_to_major_channel_number — A 10-bit number in the range of 1 to 999 that represents the “major” channel number, (as defined in Section 6.3.1 Terrestrial Virtual Channel Table or 6.3.2 Cable Virtual Channel Table).

dcc_to_minor_channel_number — A 10-bit number in the range of 1 to 999 that represents the “minor” virtual channel number, (as defined in Section 6.3.1 Terrestrial Virtual Channel Table or 6.3.2 Cable Virtual Channel Table) of a virtual channel.

The specified DCC To Channel Number shall correspond to a virtual channel currently defined in the VCT. If both a TVCT and a CVCT are present, the DCC To Channel Number shall be defined in each. The DCC To Channel Number fully identifies the virtual channel to which the DCCRR is requested to tune when the DCC request is in effect. The DCC To Channel Number shall be a major channel currently defined in the VCT and may have the "hidden" attribute.

dcc_start_time — This field shall specify the nominal start time of a DCC request, expressed as the number of GPS seconds since 00:00:00 UTC, January 6, 1980. The optimum switch point for the start of a DCC event is indicated by `splicing_point_flag` and `splice_countdown` fields. The optimum switch point for the video ES shall be indicated by its `splicing_point_flag` and `splice_countdown` fields. The optimum switch point for each audio ES should be indicated by its `splicing_point_flag` and `splice_countdown` fields. The optimum switch point for all other Elementary Streams that are elements of the program may be indicated by their `splicing_point_flag` and `splice_countdown` fields.

The `splicing_point_flag` and `splice_countdown` fields shall be carried in the adaptation fields of the TS packets carrying the Elementary Streams, as defined in Sections 2.4.3.4 and 2.4.3.5 of MPEG-2 Systems [8]. The first TS packet transmitted containing splice point information for each Elementary Stream for a given DCC request shall indicate a `splice_countdown` value of not less than 5. The channel change should nominally occur when the DCCRR's internal time of day clock (as synchronized with the System Time Table received on the same Transport Stream) reaches `dcc_start_time`, but the DCCRR should use the `splicing_point_flag` and `splice_countdown` fields to effect the timing of the switchover. The switch point timing as signaled by the MPEG-2 `splicing_point_flag` if present shall be within one second (plus or minus) of the time indicated in `dcc_start_time`. If a splice point is not detected in an ES within one second following the `dcc_start_time` and a splice countdown is not in progress, the DCCRR shall perform the Elementary Stream switch without further delay. If a splice countdown is in progress in the ES, the DCCRR should perform the elementary stream switch at the splice point.

dcc_end_time — This field shall specify the nominal endpoint of the time interval during which the DCC request shall be in effect, expressed as the number of GPS seconds since 00:00:00 UTC, January 6, 1980. The optimum switch point for the end of a Temporary Retune DCC event is indicated by `splicing_point_flag` and `splice_countdown` fields. The optimum switch point for the video ES shall be indicated by its `splicing_point_flag` and `splice_countdown` fields. The

optimum switch point for each audio ES should be indicated by its `splicing_point_flag` and `splice_countdown` fields. The optimum switch point for all other Elementary Streams that are elements of the program may be indicated by their `splicing_point_flag` and `splice_countdown` fields.

The `splicing_point_flag` and `splice_countdown` fields shall be carried in the adaptation fields of the TS packets carrying the Elementary Streams, as defined in Sections 2.4.3.4 and 2.4.3.5 of MPEG-2 Systems [8]. The first TS packet transmitted containing splice point information for each Elementary Stream for a given DCC request shall indicate a `splice_countdown` value of not less than 5. The channel change should nominally occur when the DCCRR's internal time of day clock (as synchronized with the System Time Table received on the same Transport Stream) reaches `dcc_end_time`, but the DCCRR should use the `splicing_point_flag` and `splice_countdown` fields to effect the timing of the switchover. The switch point timing as signaled by the MPEG-2 `splicing_point_flag` if present shall be within one second (plus or minus) of the time indicated in `dcc_end_time`. If a splice point is not detected in an ES within one second following the `dcc_end_time` and a splice countdown is not in progress, the DCCRR shall perform the elementary stream switch without further delay. If a splice countdown is in progress in the ES, the DCCRR should perform the Elementary Stream switch at the splice point.

dcc_term_count — This 8-bit unsigned integer specifies the number of `dcc_selection_types` and `dcc_selection_ids` to be associated with the DCC request. If the `dcc_term_count` is greater than one, the result of each `dcc_selection_type` in the "for" loop shall be evaluated as an intermediate term and then all intermediate terms for each `dcc_selection_type` logically ANDed together to determine the final result. If the final result is True (all terms evaluate True) a DCC channel change shall be indicated, otherwise no channel change shall be indicated. If it is desired to perform a combinatorial OR of individual `dcc_selection_types` then these types can be included in separate iterations of the `dcc_test_count` "for" loop. Alternatively, separate DCC Table transmissions may be sent.

A DCC request is eligible to be acted on whenever the DCCRR is tuned to the DCC From Channel Number, the current time is between the `dcc_start_time` and the `dcc_end_time`, and the result of evaluating and ANDing together all the terms in the `dcc_term_count` "for" loop is True. If one or more DCC requests in the loop are eligible to be acted on, the DCCRR shall act on the first eligible DCC request encountered in the loop. The action taken shall be tuning to the DCC To Channel Number.

dcc_selection_type — This 8-bit unsigned integer specifies the type of the value contained in the `dcc_selection_id`. Values for `dcc_selection_type` shall be as defined in Table 6.17.

Table 6.17 DCC Selection Type Assignments

dcc_selection_type	Name and Meaning	Value of DCC Selection ID	Test	Logic
* 0x00	Unconditional channel change	n.a.	Term always evaluates True.	True
* 0x01	Numeric Postal Code Inclusion — Inclusion test on numeric postal codes, with wild-card match on “?” characters	8 ASCII characters representing a specific or range of numeric character postal codes in the range 00000001 to 00099999. ASCII “?” matches any digit 0-9.	Term evaluates True if the DCCRR postal code matches, in the last five character positions, for those selection ID characters not equal to “?” and False otherwise. If postal code not specified in DCCRR, term evaluates False.	
0x02	Alphanumeric Postal Code Inclusion — Inclusion test on 8-character alphanumeric postal code, with wild-card match on “?” characters	8 ASCII characters representing an alphanumeric character postal code comprising 8 characters. ASCII “?” matches 0-9 or A-Z.	Term evaluates True if the DCCRR postal code matches, in all the character positions, for those selection ID characters not equal to “?” and False otherwise. If postal code not specified in DCCRR, term evaluates False.	
0x03-0x04	Reserved	Reserved		
0x05	Demographic Category: one or more — Test for membership in at least one indicated demographic category	A bit vector where each bit represents a demographic category	Term evaluates True if any of the selection ID bits correspond to a DCCRR membership demographic category and False otherwise.	(U & D & S) != 0
0x06	Demographic Category: all —Test for membership in all indicated demographic categories	A bit vector where each bit represents a demographic category	Term evaluates True if all of the selection ID bits correspond to DCCRR membership demographic categories and False otherwise.	(U & D & S) == D
0x07	Genre Category: one or more —Test for an interest in at least one genre category	Up to eight genre category codes	Term evaluates True if any of the selection ID category codes correspond to DCCRR interest categories and False otherwise.	(U & D & S) != 0 (see text)
0x08	Genre Category: all —Test for interest in all indicated genre categories	Up to eight genre category codes	Term evaluates True if all of the selection ID category codes correspond to DCCRR interest categories and False otherwise.	(U & D & S) == D (see text)

dcc_selection_type	Name and Meaning	Value of DCC Selection ID	Test	Logic
0x09	Cannot Be Authorized —A secondary redirect switch triggered upon detection of a failure to be authorized to remain on the requested “from” major/minor channel.	n.a.	Term evaluates True if the DCCRR cannot be authorized to decode services on the “from” channel and False otherwise.	
0x0A–0x0B	Reserved	n.a.		
0x0C	Geographic Location Inclusion	Value is a location_code conforming to the state_code, county_subdivision, and county_code.	Term evaluates True only if the DCCRR’s geographic location matches the selection ID and False otherwise. If the geographic location data is not specified in the DCC, term evaluates False.	
0x0D	Rating Blocked —Test for rating blocked.	n.a.	Term evaluates True if the current program is blocked due to content, after a timeout (to allow user to override) and False otherwise.	
0x0E	Reserved.			
* 0x0F	Return To Original Channel	n.a.	Return unconditionally to previous Virtual Channel if engaged in a DCC request.	
0x10	Reserved.	Reserved.		
* 0x11	Numeric Postal Code Exclusion — Exclusion test on numeric postal codes, with wild-card match on “?” characters	8 ASCII characters representing a specific or range of numeric character postal codes in the range 00000001 to 00099999. ASCII “?” matches any digit 0-9.	Term evaluates True if the DCCRR postal code does not match, in the last five character positions, for those selection ID characters not equal to “?”, and False otherwise. If postal code not specified, term evaluates False.	
0x12	Alphanumeric Postal Code Exclusion — Exclusion test on 8-character alphanumeric postal code, with wild-card match on “?” characters	8 ASCII characters representing an alphanumeric character postal code comprising 8 characters. ASCII “?” matches 0-9 or A-Z.	Term evaluates True if the DCCRR postal code does not match, for those selection ID characters not equal to “?” and False otherwise. If postal code not specified, term evaluates False.	
0x13-0x14	Reserved.	Reserved.		

dcc_selection_type	Name and Meaning	Value of DCC Selection ID	Test	Logic
0x15	Demographic Category: one or more non-member —Test for non-membership in at least one indicated demographic category	A bit vector where each bit represents a demographic category	Term evaluates True if any of the selection ID bits correspond to DCCRR non-membership in that demographic category and False otherwise.	$(\sim U \& D \& S) \neq 0$
0x16	Demographic Category: all non-member —Test for non-membership in all the indicated demographic categories	A bit vector where each bit represents a demographic category	Term evaluates True if all of the selection ID bits correspond to DCCRR non-membership demographic categories and False otherwise.	$(\sim U \& D \& S) == D$
0x17	Genre Category: one or more non-member —Test for non-interest in at least one indicated genre category	Up to eight genre category codes	Term evaluates True if any of the selection ID category codes correspond to genres of no interest in the DCCRR and False otherwise.	$(\sim U \& D \& S) \neq 0$ (see text)
0x18	Genre Category: all non-member —Test for non-interest in all the indicated genre categories	Up to eight genre category codes	Term evaluates True if all of the selection ID category codes correspond to genres of no interest in the DCCRR and False otherwise.	$(\sim U \& D \& S) == D$ (see text)
0x19-0x1B	Reserved	Reserved		
0x1C	Geographic Location Exclusion	Value is a location_code conforming to the state_code, county_subdivision, and county_code.	Term evaluates True if the DCCRR’s geographic location does not match the selection ID and False otherwise. If the geographic location data is not specified in the DCC, term evaluates False.	
0x1D-0x1F	Reserved	Reserved		
* 0x20-0x23	Viewer-Direct-Select — 0x20 corresponds to Button A; 0x21 corresponds to Button B; 0x22 corresponds to Button C; and 0x23 corresponds to Button D.	A 64-bit number associated with a given button choice; used in the VDS “persistence” function. See text.	Tune to the channel associated with the indicated function button if that button is selected. Term always evaluates True when viewer presses a Direct Select button.	
0x24-0xFF	Reserved.	Reserved.		

Table Legend and Notes

D = DCC Selection ID data: data sent within the dcc_selection_id field.

U = User-entered DCCRR data: data stored in non-volatile DCCRR memory that is entered by the user to establish the user's selected choices.

S = Specification mask indicating validity of U (i.e. user has entered a value for U): data stored in non-volatile DCCRR memory that indicates that a user has specified a choice for the associated data item.

NOTE: Items marked with an asterisk (*) above are required within a DTV device providing minimal support for Directed Channel Change within the United States.

Operators used within Table 6.17:

& bitwise AND
== equal to
~ 1's complement (bitwise inversion)
!= not equal to

dcc_selection_id — This 64-bit unsigned integer contains the data identified by the `dcc_selection_type` field, and is described below. Note: 8 bit characters specified for use within this section shall mean characters defined in ISO/IEC 8859-1 (ISO Latin-1) [6].

6.7.3 Case: Unconditional Channel Change (`dcc_selection_type = 0x00`)

If the `dcc_selection_type` is specified to be of type “unconditional” (0x00), the `dcc_selection_id` shall be 0x00 and the DCCRR shall unconditionally switch to the DCC To Channel Number if the current time is within the interval bounded by `dcc_start_time` and `dcc_end_time`.

6.7.4 Case: Numeric Postal Code (`dcc_selection_type = 0x01, 0x11`)

If the `dcc_selection_type` is specified to be of type 0x01 or 0x11, the `dcc_selection_id` shall consist of a right-justified five numeric 8-bit character postal code field in the range of 00001 to 99999 padded on the left with “0” (0x30) characters. The DCCRR shall compare that value to a stored representation of a numeric postal code entered by the user from setup menus within the DCCRR to determine if there is a match. If a question mark (“?” or 0x3F) character appears in any of the five least significant numeric character positions, that position shall be considered to be a wild card which will permit a selection on any numeric digit within that position. For example 00055?98 would permit matches on 00055098, 00055198, 00055298, 00055398, ..., and 00055998. Similarly, 00055??8 would permit matches on 00055008, 00055018, 00055028, ..., 00055108, 00055118, ..., and 00055908, 00055918, ..., and 00055998. Note that multiple numeric postal code specifications may be made within a single DCCT by means of the `dcc_term_count` loop.

If the `dcc_selection_type` is defined to be of type 0x01, the term shall evaluate True if the numeric postal code (with evaluated wild cards if any) given in the `dcc_selection_id` matches the stored numeric postal code entered by the user and False otherwise.

If the `dcc_selection_type` is defined to be of type 0x11, the term shall evaluate True if the numeric postal code (with evaluated wild cards if any) given in the `dcc_selection_id` does not match the stored numeric postal code entered by the user and False otherwise.

6.7.5 Case: Alphanumeric Postal Code (`dcc_selection_type = 0x02, 0x12`)

If the `dcc_selection_type` is specified to be of type 0x02 or 0x12, the `dcc_selection_id` shall consist of a right justified eight alphanumeric and special 8-bit character postal code field of unspecified format padded on the left with space characters (0x20). The field may also contain separator characters, as necessary, to format the postal code according to country conventions. The separator characters may consist of any of the following special characters: comma (0x2C), dash (0x2D), period (0x2E), slash (0x2F) or space (0x30). The separator characters shall be considered to be “do not care” placeholders for purposes of logical comparison to a postal code stored within the DCCRR. The DCCRR shall compare that value to a stored representation of a postal code entered by the user from setup menus within the DCCRR to determine if there is a match.

The alphanumeric and special characters permitted shall be any printing character within the character set from 0x20 through 0x7E inclusive. If a question mark (“?” or 0x3F) character appears in any of the eight character positions, that position shall be considered to be a wildcard which will permit a selection on any character within that position. For example “5B3-5Q?” would permit matches on 5B3-5Q0 through 5B3-5Q9 assuming the postal format convention was a numeric character in the rightmost character position. Similarly, “5B3-5?3” would permit

matches on 5B3-5A3 through 5B3-5Z3 assuming the postal format convention for the second from the rightmost character is alphabetic. Note that multiple postal codes may be specified within a single DCCT by means of the `dcc_term_count` loop.

If the `dcc_selection_type` is defined to be of type 0x02, the term shall evaluate True if the alphanumeric postal code (with evaluated wild cards if any) given in the `dcc_selection_id` matches the stored alphanumeric postal code entered by the user and False otherwise.

If the `dcc_selection_type` is defined to be of type 0x12, the term shall evaluate True if the alphanumeric postal code (with evaluated wild cards if any) given in the `dcc_selection_id` does not match the stored alphanumeric postal code entered by the user and False otherwise.

6.7.6 Case: Demographic Category (`dcc_selection_type` = 0x05, 0x06, 0x15, 0x16)

If `dcc_selection_type` is equal to 0x05, 0x06, 0x15, or 0x16, the `dcc_selection_id` shall be specified to be a demographic selection bit field composed of one or more of the values described in Table 6.18 logically ORed together. The DCCRR shall perform a comparison, based upon the `dcc_selection_type`, of the value to a stored value within the DCCRR which had been entered by the user within setup menus to determine if there is a match.

Table 6.18 Demographic Selection Type Assignments

Value	Meaning
0x0000000000000001	Males
0x0000000000000002	Females
0x0000000000000004	Ages 2-5
0x0000000000000008	Ages 6-11
0x0000000000000010	Ages 12-17
0x0000000000000020	Ages 18-34
0x0000000000000040	Ages 35-49
0x0000000000000080	Ages 50-54
0x0000000000000100	Ages 55-64
0x0000000000000200	Ages 65+
0x0000000000000400	Working
0x0000000000000800 - 0x8000000000000000	Reserved

If the selection is specified to be of type "One-or-More Members" (`dcc_selection_type` 0x05), the received value within `dcc_selection_id` shall be logically bitwise ANDed with the DCCRR's stored value and then logically bitwise ANDed with a specification mask that indicates whether the viewer had entered values for each demographic selection category. If the result is non-zero, the term shall evaluate True. If the result is zero, the term shall evaluate False. This test permits selection based upon membership in at least one and possibly more demographic categories. In other words, the term evaluates True if any of the categories that had been selected and validated by the viewer correspond with membership in the demographic categories specified in the `dcc_selection_id` field of the DCCT.

If the selection is specified to be of type "One-or-More Non-members" (`dcc_selection_type` 0x15), the received value within `dcc_selection_id` shall be logically bitwise ANDed with the 1's complement of the DCCRR's stored value and then logically bitwise ANDed with a

specification mask that indicates whether the viewer had entered values for each demographic selection category. If the result is non-zero, the term shall evaluate True. If the result is zero, the term shall evaluate False. This test permits selection based upon non-membership in at least one and possibly more demographic categories. In other words, the term evaluates True if any of the categories that had been selected and validated by the viewer correspond with non-membership in the DCC demographic categories specified in the `dcc_selection_id` field of the DCCT.

If the selection is specified to be of type "All Members" (`dcc_selection_type` 0x06), the received value within `dcc_selection_id` shall be logically compared to the DCCRR's stored value which has been logically bitwise ANDed with a specification mask that indicates whether the viewer had entered values for each demographic selection category. If the result of the comparison is that the values are equal, the term shall evaluate True, and shall evaluate False otherwise. This test permits selection based upon membership in all requested demographic categories. In other words, the term evaluates True if the categories that had been selected and validated by the viewer correspond with membership in all of the DCC demographic categories specified in the `dcc_selection_id` field of the DCCT.

If the selection is specified to be of type "All Non-members" (`dcc_selection_type` 0x16), the received value within `dcc_selection_id` shall be logically bitwise ANDed with the 1's complement of the DCCRR's stored value and then logically bitwise ANDed with a specification mask that indicates whether the viewer had entered values for each demographic selection category. That result shall be compared to the DCCRR's stored value. If the result of the comparison is that the values are equal, the term shall evaluate True, and shall evaluate False otherwise. This test permits selection based upon non-membership in all requested demographic categories. In other words, the term evaluates True if the categories that had been selected and validated by the viewer correspond with non-membership in all of the DCC demographic categories specified in the `dcc_selection_id` field of the DCCT.

6.7.7 Case: Genre Category (`dcc_selection_type` = 0x07, 0x08, 0x17, 0x18)

If `dcc_selection_type` is equal to 0x07, 0x08, 0x17, or 0x18, the `dcc_selection_id` shall be specified to be a genre category selection code field. The DCCRR shall compare the code values obtained from the `dcc_selection_id` field to stored values which had been entered by the user through selection setup menus to determine if there is a match. Each occurrence of the `dcc_selection_id` may contain up to eight categorical selection codes, each code having a length of eight bits.

Up to a maximum of eight 8-bit Genre Category selection codes may be specified. Genre Category selection code bytes shall be placed right-justified in the 64-bit `dcc_selection_id` field. Each of the codes present shall consist of a value in the range 0x01 through 0xFF. If fewer than eight codes are specified, the remaining bytes in the `dcc_selection_id` field shall each contain 0x00. Table 6.19 illustrates the categorical selection criteria code placement within the `dcc_selection_id` field for four examples.

Table 6.19 Examples of Selection Code Packing

Value	Meaning
0x0000000000000000	no codes specified
0x0000000000222120	3 codes in least significant 24 bits
0x0000000052304120	4 codes in least significant 32 bits
0x3031323334353620	8 codes in 64 bits

If the selection is specified to be of type "One-or-More Members" (`dcc_selection_type 0x07`), each of the individual eight byte values received within `dcc_selection_id` shall be compared with data in the DCCRR's stored value tables. Each compare results in a "1" if the category corresponds to one of interest and "0" if not. That 8-bit result is ANDed with the S mask corresponding to whether choices have been registered for each of those categories. If the result is non-zero, the term shall evaluate True, and shall evaluate False otherwise. This test permits selection based upon interest membership in at least one and possibly more of the genre categories according to the Categorical Genre Code Assignment table (Table 6.20) including any downloaded extensions to that table. In other words, the term evaluates True if the genre categories that had been selected and validated by the viewer correspond with interest in any of the of the genre categories specified in the `dcc_selection_id` field of the DCCT.

Table 6.20 Categorical Genre Code Assignments

Value	Meaning	Value	Meaning	Value	Meaning
0x00	Not Available	0x4F	Hobby	0x80	Art
0x01-1F	Reserved (Basic)	0x50	Hockey	0x81	Auto Racing
0x20	Education	0x51	Home	0x82	Aviation
0x21	Entertainment	0x52	Horror	0x83	Biography
0x22	Movie	0x53	Information	0x84	Boating
0x23	News	0x54	Instruction	0x85	Bowling
0x24	Religious	0x55	International	0x86	Boxing
0x25	Sports	0x56	Interview	0x87	Cartoon
0x26	Other	0x57	Language	0x88	Children
0x27	Action	0x58	Legal	0x89	Classic Film
0x28	Advertisement	0x59	Live	0x8A	Community
0x29	Animated	0x5A	Local	0x8B	Computers
0x2A	Anthology	0x5B	Math	0x8C	Country Music
0x2B	Automobile	0x5C	Medical	0x8D	Court
0x2C	Awards	0x5D	Meeting	0x8E	Extreme Sports
0x2D	Baseball	0x5E	Military	0x8F	Family
0x2E	Basketball	0x5F	Miniseries	0x90	Financial
0x2F	Bulletin	0x60	Music	0x91	Gymnastics
0x30	Business	0x61	Mystery	0x92	Headlines
0x31	Classical	0x62	National	0x93	Horse Racing
0x32	College	0x63	Nature	0x94	Hunting/Fishing/Outdoors
0x33	Combat	0x64	Police	0x95	Independent
0x34	Comedy	0x65	Politics	0x96	Jazz
0x35	Commentary	0x66	Premier	0x97	Magazine
0x36	Concert	0x67	Prerecorded	0x98	Motorcycle Racing
0x37	Consumer	0x68	Product	0x99	Music/Film/Books
0x38	Contemporary	0x69	Professional	0x9A	News-International
0x39	Crime	0x6A	Public	0x9B	News-Local
0x3A	Dance	0x6B	Racing	0x9C	News-National
0x3B	Documentary	0x6C	Reading	0x9D	News-Regional
0x3C	Drama	0x6D	Repair	0x9E	Olympics
0x3D	Elementary	0x6E	Repeat	0x9F	Original
0x3E	Erotica	0x6F	Review	0xA0	Performing Arts
0x3F	Exercise	0x70	Romance	0xA1	Pets/Animals
0x40	Fantasy	0x71	Science	0xA2	Pop
0x41	Farm	0x72	Series	0xA3	Rock & Roll
0x42	Fashion	0x73	Service	0xA4	Sci-Fi
0x43	Fiction	0x74	Shopping	0xA5	Self Improvement
0x44	Food	0x75	Soap Opera	0xA6	Sitcom
0x45	Football	0x76	Special	0xA7	Skating
0x46	Foreign	0x77	Suspense	0xA8	Skiing
0x47	Fund Raiser	0x78	Talk	0xA9	Soccer
0x48	Game/Quiz	0x79	Technical	0xAA	Track/Field
0x49	Garden	0x7A	Tennis	0xAB	True
0x4A	Golf	0x7B	Travel	0xAC	Volleyball
0x4B	Government	0x7C	Variety	0xAD	Wrestling
0x4C	Health	0x7D	Video	0xAE-FE	Reserved (Detailed)
0x4D	High School	0x7E	Weather	0xFF	Null (not a category)
0x4E	History	0x7F	Western		

If the selection is specified to be of type "One-or-More Non-members" (`dcc_selection_type` 0x17), each of the individual eight byte values received within `dcc_selection_id` shall be compared with data in the DCCRR's stored value tables. Each compare results in a "1" if the category does not correspond to one of interest and "0" if it does. That 8-bit result is ANDed with the S mask corresponding to whether choices have been registered for each of those categories. If the result is non-zero, the term shall evaluate True, and shall evaluate False otherwise. This test permits selection based upon non-membership (meaning no interest) in at least one and possibly more specified genre categories. In other words, the term evaluates True if the categories that had been selected and validated by the viewer correspond with non-interest in any of the genre categories specified in the `dcc_selection_id` field of the DCCT.

If the selection is specified to be of type "All Members" (`dcc_selection_type` 0x08), each of the individual eight byte values received within `dcc_selection_id` shall be compared with data in the DCCRR's stored value tables. Each compare results in a "1" if the category corresponds to one of interest and "0" if not. That 8-bit result is compared with the S mask corresponding to whether choices have been registered for each of those categories. If the result is equal, the term shall evaluate True, and shall evaluate False otherwise. This test permits selection based upon interest in all specified genre categories. In other words, the term evaluates True if the categories that had been selected and validated by the viewer resulted in interest in all of the genre categories specified in the `dcc_selection_id` field of the DCCT.

If the selection is specified to be of type "All Non-members" (`dcc_selection_type` 0x18), each of the individual eight byte values received within `dcc_selection_id` shall be compared with data in the DCCRR's stored value tables. Each compare results in a "1" if the category does not correspond to one of interest and "0" if it does. That 8-bit result is compared with the S mask corresponding to whether choices have been registered for each of those categories. If the result is equal, the term shall evaluate True, and shall evaluate False otherwise. This test permits selection based upon non-membership (meaning no interest) in all specified genre categories. In other words, the term evaluates True if the categories that had been selected and validated by the viewer resulted in no interest in all of the genre categories specified in the `dcc_selection_id` field of the DCCT.

The list of category names and their respective codes (Table 6.20) are broken down into two groups. The first group consists of codes 0x20 through 0x26 and may be called the "Basic" group. The second group contains the codes 0x27 through 0xAD and is called the "Detail" group.

The DCC Selection Code Table (see Sec. 6.8) can extend the codes given in Table 6.20. New entries in the Basic group can be defined in the range 0x01 to 0x1F. New entries in the Detail group can be defined in the range 0xAE to 0xFE.

6.7.8 Case: Cannot Be Authorized (`dcc_selection_type` = 0x09)

If the `dcc_selection_type` is specified to be of type 0x09, and if the DCCRR has been tuned by the viewer to a major and minor channel number specified by the `dcc_from_major_channel_number` and the `dcc_from_minor_channel_number` for which the viewer is not authorized (due to conditional access), the DCCRR shall promptly, upon determination of the unauthorized status, tune to the `dcc_to_major_channel_number` and `dcc_to_minor_channel_number`. The action of this mechanism provides an ability to "redirect" viewers to an alternate channel in the event they are not authorized to view the requested channel.

6.7.9 Case: Geographic Location (dcc_selection_type = 0x0C, 0x1C)

location_code — This 24-bit unsigned integer field contains state_code, county_subdivision, and county_code sub fields (defined below) used in identification of a geographic location.

For dcc_selection_type 0x0C, Geographic Location Inclusion, the term shall evaluate True if the geographic location indicated in the matches the geographic location of the DCCRR. If the geographic location indicated in the dcc_selection_id does not match the geographic location of the DCCRR, or if the DCCRR's geographic location is not known, the term shall evaluate False.

For dcc_selection_type 0x1C, Geographic Location Exclusion, the term shall evaluate True if the geographic location indicated in the dcc_selection_id does not match the geographic location of the DCCRR. If the geographic location indicated in the dcc_selection_id matches the geographic location of the DCCRR, or if the DCCRR's geographic location is not known, the term shall evaluate False.

The location_code fields shall be as specified in Table 6.21.

Table 6.21 Conditional Type Value Format

Syntax	No. of Bits	Format
dcc_selection_id {		
reserved	40	0xFFFFFFFF
location_code {		
state_code	8	uimsbf range 0..99
county_subdivision	4	uimsbf range 0..9
reserved	2	'11'
county_code	10	uimsbf rang 0..999
}		
}		

state_code — An 8-bit unsigned number in the range 0 to 99 that represents the affected State, Territory or Offshore (Marine Area). state_code shall be coded according to State and Territory FIPS number codes according to 47 CFR § 11.31(f) [12]. The value of 0 shall indicate all states.

county_subdivision — This 4-bit unsigned integer in the range 0 to 9 specifies county subdivisions and shall be defined as shown in Table 6.22.

Table 6.22 County Subdivision Coding

county_subdivision	Meaning
0x0	All or an unspecified portion of a county
0x1	Northwest
0x2	North Central
0x3	Northeast
0x4	West Central
0x5	Central
0x6	East Central
0x7	Southwest
0x8	South Central
0x9	Southeast
0xA-0xF	[Reserved]

county_code — An unsigned number in the range 0 to 999 that identifies a county within a state identified by state_code. county_code shall be the numeric representation of the “CCC” field in the EAS Protocol as defined in 47 CFR § 11.31(c) [12], which states that county codes use the “State and Territory Federal Information Processing Standard (FIPS) numbers as described by the U.S. Department of Commerce in the National Institute of Standards and Technology publication FIPS PUB 6-4.” [18] A value 0 shall indicate the entire state, territory or offshore (marine) area.

6.7.10 Case: Rating Blocked (dcc_selection_type = 0x0D)

If the dcc_selection_type is specified to be of type 0x0D the term shall evaluate True if the current Virtual Channel is "blocked" as defined in CEA-766-A [17] due to its Content Advisory and shall evaluate False otherwise. At the discretion of the DCCRR implementation, a timeout may be employed prior to the channel change to allow the viewer to override the blocked condition, for example by entering a parental password. Note that dcc_departing_request_descriptors and dcc_arriving_request_descriptors may be employed to provide a message to viewers that a channel-blocked situation has arisen and that the DCCRR has switched to a new channel.

6.7.11 Case: Return to Original Channel (dcc_selection_type = 0x0F)

If the dcc_selection_type is specified to be of type 0x0F, and if the DCCRR is engaged in a DCC request of type Temporary Retune (dcc_context = 0), the DTV shall tune back to the channel from which it was previously directed (the previous DCC From Channel Number).

6.7.12 Case: Viewer-Direct-Select (dcc_selection_type = 0x20 – 0x23)

If the dcc_selection_type is specified to be of type 0x20 through 0x23, the DCCRR shall tune to the virtual channel specified in the DCC To Channel Number based upon the viewer’s selection of one of four “Viewer-Direct-Select” (VDS) function buttons (or equivalent). To correspond with textual or verbal prompting in the video program, the buttons shall be labeled or otherwise identified to the user as “A,” “B,” “C,” and “D.” For example, if the viewer chooses Viewer-Direct-Select Button B and a DCC request has been defined for that button (dcc_selection_type value 0x21), the DCCRR shall immediately switch to the DCC To Channel Number associated with the request.

For dcc_selection_type values 0x20 through 0x23, the dcc_selection_id field is a 64-bit number that, when non-zero, enables a Viewer-Direct-Select “persistence” function. Value zero for the dcc_selection_id field for dcc_selection_type values 0x20 through 0x23 indicate that a persistence function for this button choice for this DCC request is not offered.

6.7.13 Viewer-Direct-Select Persistence

The DCCRR shall implement a persistence function for the VDS DCC function. The persistence function allows the DCCRR to automatically take the same branch that was chosen by a prior VDS button selection when a new VDS opportunity arises. The following rules shall be followed:

- 1) If in response to a VDS opportunity the user selects a button, the DCCRR shall record the value of that button’s 64-bit dcc_selection_id (if non-zero).

If a new VDS opportunity arises in which a 64-bit dcc_selection_id value appears that corresponds to a recorded ID, the DCCRR shall use that branch as the default (the branch to be taken if no button is selected).

- 2) If a new VDS opportunity arises in which a 64-bit `dcc_selection_id` value appears that matches more than one recorded ID, the DCCRR shall take as the default branch the one associated with the most recently saved ID of those matching.
- 3) Recorded IDs shall be saved in a stack in the DCCRR. The requirements regarding the size and organization of this stack are not specified and are left to the discretion of the implementer.

The way in which the 64-bit VDS ID numbers are managed and assigned is outside the scope of this document. If broadcasters intend for them to work across different transmissions, coordination of their assignment will be required. If they want them *not* to work across to other broadcaster's transmissions, appropriate steps should be taken to assure the 64 bit number is suitably random across the full 64-bit number space.

dcc_selection_id — This 64-bit unsigned integer contains the data identified by the `dcc_selection_type` field that has been described above in each of the case descriptions and summarized in Table 6.17.

dcc_term_descriptors_length — A 10-bit unsigned integer number that indicates the number of bytes of optional DCC term descriptors (if any) to follow. DCC term descriptors are an expansion mechanism allowing, in a future revision of this protocol, additional data to be associated with a given term. At present, no descriptors are defined for such use. The DCCRR shall disregard any descriptors encountered.

dcc_term_descriptor() — A data structure in standard descriptor format (tag, length, data) that provides additional information about the term defined in this iteration of the `dcc_term_count` “for” loop.

dcc_test_descriptors_length — A 10-bit unsigned integer number that indicates the number of bytes of optional DCC test descriptors (if any) to follow. DCC test descriptors can provide an additional piece of data to be associated with a given test. At present, two descriptors are defined for such use, the `dcc_departing_request_descriptor()` defined in Section 6.9.11 and the `dcc_arriving_request_descriptor()` defined in Section 6.9.12. The DCCRR shall disregard any unsupported descriptors encountered.

dcc_test_descriptor() — A data structure in standard descriptor format (tag, length, data) that provides additional information about the test defined in this iteration of the `dcc_test_count` “for” loop.

dcc_additional_descriptors_length — A 10-bit unsigned integer number that indicates the number of bytes of optional DCC additional descriptors (if any) to follow. DCC additional descriptors are an expansion mechanism allowing, in a future revision of this protocol, additional data to be associated with a given DCC table section. At present, no descriptors are defined for such use.

dcc_additional_descriptor() — A data structure in standard descriptor format (tag, length, data) that provides additional information about the DCC requests described in this `directed_channel_change_table_section()`.

CRC_32 — This is a 32-bit field that contains the CRC value that ensures a zero output from the registers in the decoder defined in Annex A of ISO/IEC 13818-1 [8] after processing the entire Directed Channel Change Table section.

6.8 DCC Selection Code Table (DCCSCT)

The optional Directed Channel Change Selection Code Table (DCCSCT) carries genre code values and genre criteria name values and/or state/county location codes for use in extending the original data sets of those codes defined in Table 6.20 and Annex H.

The DCC Selection Code Table is carried in private sections with table ID 0xD4, and obeys the syntax and semantics given in Section 4.

The following constraints apply to the Transport Stream packets carrying DCCSCT sections.

- PID shall have the value 0x1FFB (base_PID)
- transport_scrambling_control bits shall have the value '00'
- adaptation_field_control bits shall have the value '01'

The bit stream syntax for the Directed Channel Change Selection Code Table shall be as shown in Table 6.23.

Table 6.23 Bit Stream Syntax for the DCC Selection Code Table

Syntax	No. of Bits	Format
<code>dcc_selection_code_table_section () {</code>		
table_id	8	0xD4
section_syntax_indicator	1	'1'
private_indicator	1	'1'
reserved	2	'11'
section_length	12	uimbsf
dccsct_type	16	uimbsf
reserved	2	'11'
version_number	5	uimbsf
current_next_indicator	1	'1'
section_number	8	0x00
last_section_number	8	0x00
protocol_version	8	uimbsf
updates_defined	8	uimbsf
for (i = 0; i < updates_defined; i++) {		
update_type	8	uimbsf
update_data_length	8	uimbsf
if (update_type==new_genre_category) {		
genre_category_code	8	uimbsf
genre_category_name_text()	var	
}		
if (update_type==new_state) {		
dcc_state_location_code	8	uimbsf
dcc_state_location_code_text()	var	
}		
if (update_type==new_county) {		
state_code	8	uimbsf
reserved	6	'111111'
dcc_county_location_code	10	uimbsf
dcc_county_location_code_text()	var	
}		
reserved	6	'111111'
dccsct_descriptors_length	10	uimbsf
for (j = 0; j < N; j++) {		
dccsct_descriptors()		
}		
}		
reserved	6	'111111'
dccsct_additional_descriptors_length	10	uimbsf
for (i = 0; i < N; i++) {		
dccsct_additional_descriptors()		
}		
CRC_32	32	rpchof
}		

table_id — This is an 8-bit field, which shall be set to 0xD4, identifying this table as the DCC Selection Code Table (DCCSCT).

section_syntax_indicator — This 1-bit field shall be set to '1'. It denotes that the section follows the generic section syntax beyond the section length field.

- private_indicator** — This 1-bit field shall be set to ‘1’.
- section_length** — 12-bit field specifying the number of remaining bytes in this section immediately following the section_length field up to the end of the section.
- dccsct_type** — A 16-bit unsigned integer field whose value specifies the type of DCC selection code information contained within the table section, and its syntax and semantics. Currently only dccsct_type value 0x0000 is defined. The DCCRR is expected to discard DCCSCT table sections with nonzero values of dccsct_type until such time as they are standardized and supported.
- version_number** — This 5-bit field is the version number of the DCCSC Table identified by the combination of the table_id and dccsct_type fields. The version number shall be incremented by 1 modulo 32 when any field in this instance of the DCC Selection Code Table changes. The value of the version_number shall be identical to that of the corresponding entry in the MGT.
- current_next_indicator** — This 1-bit indicator is always set to ‘1’.
- section_number** — The value of this 8-bit field shall always be 0x00.
- last_section_number** — The value of this 8-bit field shall always be 0x00.
- protocol_version** — An 8-bit unsigned integer field whose function is to allow, in the future, this table type to carry parameters that may be structured differently than those defined in the current protocol. At present, the only valid value for protocol_version is 0x00. Non-zero values of protocol_version may be used by a future version of this standard to indicate structurally different tables.
- update_type** – This 8-bit field indicates the type of update to be supplied in this iteration of the “for” loop. The coding shall be as defined in Table 6.24 .

Table 6.24 Update Type Coding

update_type	Meaning
0x00	Reserved
0x01	new_genre_category —Genre table update
0x02	new_state —Addition to state code data
0x03	new_county —Addition to county code data
0x04-0xFF	Reserved for future use

- update_data_length** – An unsigned integer field that shall indicate the number of bytes of data in the “if” statement to follow. After skipping ahead the number of bytes given by update_length, the next field will be the 6-bit reserved field ahead of dccsct_descriptors_length. Receiving devices are expected to use update_data_length to skip data for unknown values of update_type.
- genre_category_code** – An 8-bit unsigned integer code that references a reserved value in the Categorical Genre Code Assignment Table (Table 6.20). Values for genre_category_code shall be in the range 0x01 to 0x1F for expansion of the Basic genre categories, or in the range 0xAE through 0xFE for expansion of the Detailed genre categories. The integer values specifying new Categorical Genre Codes shall be those assigned by the ATSC.
- selection_category_name_text()** — A data structure containing a multiple string structure which specifies the genre category name; e.g., “Rugby.” Text strings are formatted according to the

rules outlined in Section 6.12. The displayed string for the genre category name shall be limited to 24 characters or less.

dcc_state_location_code — This 8-bit unsigned integer in the range 79 to 99 specifies the State or Territory to be added. The integer values specifying new States or Territories shall be those assigned by the ATSC.

dcc_state_location_code_text() — The name of the new State or Territory in the format of a multiple string structure (see Section 6.12).

state_code — An 8-bit unsigned number in the range 0 to 99 that identifies the State, Territory or Offshore (Marine Area) to which the county information to follow applies. `state_code` shall be coded according to State and Territory FIPS number codes according to 47 CFR § 11.31(f) [12] plus the codes for any new states added by state updates in this DCCSCT.

dcc_county_location_code — This 10-bit unsigned integer in the range 1 to 999 specifies a new county within the state identified in `state_code`. Allowed values for `dcc_county_location_code` shall be limited to values not already established by the U.S. Department of Commerce in the National Institute of Standards and Technology publication FIPS PUB 6-4” [18].

for the state identified in `state_code`¹². The integer values specifying new counties shall be those assigned by the ATSC.

dcc_county_location_code_text() — The name of a new county in the format of a multiple string structure (see Section 6.12).

dccsct_descriptors_length — Total length of the descriptor list that follows (in bytes).

dccsct_descriptors() — Zero or more descriptors, as appropriate, may be included.

CRC_32 — This is a 32-bit field that contains the CRC value that ensures a zero output from the registers in the decoder defined in Annex A of ISO/IEC 13818-1 “MPEG-2 Systems” [8] after processing the entire DCC Selection Code Table section.

6.9 Core Descriptors

Table 6.25 lists descriptor tags along with their names, and shows the use of each when the relevant table section listed is present in the transport stream. Table 6.25 indicates all the core descriptors, their tags, and their allowed locations in the PSIP tables. The `service_location_descriptor()` shall always be present in the terrestrial VCT (shown with an “S”). Table 6.25 does not specify the rules governing whether or not a particular descriptor must be present in any given situation. When used, some descriptors shall be in each indicated location (shown with an “M”). Some descriptors also may be present in a second location within either the terrestrial or the cable case (shown with an “O”). Asterisks mark the tables where the descriptors may appear without restrictions.

¹² If a county changes its name, the convention is to add a new county code rather than re-define the old one.

Table 6.25a List and Location of PSIP Descriptors

Descriptor Name	Descriptor Tag	Terrestrial Broadcast					
		PMT	MGT	VCT	EIT	DCCT	DCCSCT
stuffing descriptor	0x80	*	*	*	*	*	*
AC-3 audio descriptor	0x81	M			M		
caption service descriptor	0x86	O			M		
content advisory descriptor	0x87	O			M		
extended channel name descriptor	0xA0			M			
service location descriptor	0xA1			S			
time-shifted service descriptor	0xA2			M			
component name descriptor	0xA3	M					
DCC departing request descriptor	0xA8					M	
DCC arriving request descriptor	0xA9					M	
redistribution control descriptor	0xAA	M			M		
ATSC private information descriptor	0xAD	*	*	*	*	*	*
content identifier descriptor	0xB6	O			M		
Genre descriptor	0xAB				M		

Table 6.25b List and Location of PSIP Descriptors

Descriptor Name	Descriptor Tag	Cable					
		PMT	MGT	VCT	EIT	DCCT	DCCSCT
stuffing descriptor	0x80	*	*	*	*	*	*
AC-3 audio descriptor	0x81	M			M		
caption service descriptor	0x86	M			M		
content advisory descriptor	0x87	M			M		
extended channel name descriptor	0xA0			M			
service location descriptor	0xA1			M			
time-shifted service descriptor	0xA2			M			
component name descriptor	0xA3	M					
DCC departing request descriptor	0xA8					M	
DCC arriving request descriptor	0xA9					M	
redistribution control descriptor	0xAA	M			M ¹³		
ATSC private information descriptor	0xAD	*	*	*	*	*	*
content identifier descriptor	0xB6				M		
Genre descriptor	0xAB				M		

The descriptors listed here are those currently defined. Others may be defined in the future. Receivers are expected to tolerate the presence of any descriptor within any descriptor loop in

¹³ When the EIT is present.

any table section. Additions to PSIP functionality are contemplated in the future and may result in additional descriptors being present in each of these tables.

6.9.1 AC-3 Audio Descriptor

The `AC-3_audio_stream_descriptor()` (AC-3 audio descriptor), of ATSC A/53D [1] shall be used in the EIT when there is one or more audio service planned for or present as an element of the event. This enables, for example, announcement of audio language and stereo or 5.1 channels. If there is no audio service associated with the EIT event, the `AC-3_audio_stream_descriptor()` shall not be present for that event.

6.9.2 Caption Service Descriptor

The caption service descriptor provides closed captioning information, such as closed captioning type and language code for events with closed captioning service. This descriptor shall appear as a descriptor in the `descriptor()` field for each EIT event that has one or more closed captioning services during some portion of the event. If there is no captioning during the EIT event, the `caption_service_descriptor()` shall not be present for that event.

The bit stream syntax for the closed captioning service descriptor shall be as shown in Table 6.26.

Table 6.26 Bit Stream Syntax for the Caption Service Descriptor

Syntax	No. of Bits	Format
<code>caption_service_descriptor () {</code>		
descriptor_tag	8	0x86
descriptor_length	8	uimsbf
reserved	3	'111'
number_of_services	5	uimsbf
for (i=0;i<number_of_services;i++) {		
language	8*3	uimsbf
digital_cc	1	bslbf
reserved	1	'1'
if (digital_cc==line21) {		
reserved	5	'11111'
line21_field	1	bslbf
}		
else		
caption_service_number	6	uimsbf
easy_reader	1	bslbf
wide_aspect_ratio	1	bslbf
reserved	14	'11111111111111'
}		
}		

descriptor_tag — An 8-bit field that identifies the type of descriptor. For the `caption_service_descriptor()` the value is 0x86.

descriptor_length — An 8-bit count of the number of bytes following the `descriptor_length` itself.

number_of_services — An unsigned 5-bit integer in the range 1 to 16 that indicates the number of closed caption services present in the associated EIT event.

Each iteration of the “for” loop defines one closed caption service that is present as a sub-stream within the 9600 bit per second closed captioning stream. Each iteration provides the service’s language, attributes, and (for digital captions) the associated caption service number. Refer to CEA-708-B [4] for a description of the use of the service number field within the syntax of the closed caption stream.

language — A 3-byte language code per ISO 639.2/B [5] defining the language associated with one closed caption service. The language field contains a three-character code as specified by ISO 639.2/B. Each character is coded into 8 bits according to ISO 8859-1 (ISO Latin-1) and inserted in order into the 24-bit field. When the `digital_cc` flag is clear, this field has no meaning.

digital_cc — A flag that indicates, when set, that an digital television closed caption service is present in accordance with CEA-708-B [4]. When the flag is clear, a line-21 closed caption service is present encapsulated per CEA-708-B [4].

line21_field —Deprecated and may be set or clear.

caption_service_number — A 6-bit unsigned integer value in the range zero to 63 that identifies the caption service number within the closed captioning stream that is associated with the language and attributes defined in this iteration of the “for” loop. See CEA-708-B [4] for a description of the use of the caption service number. The `caption_service_number` field is defined only if the `digital_cc` flag indicates closed captioning in accordance with CEA-708-B [4]. The value of zero is prohibited.

easy_reader — A Boolean flag which indicates, when set, that the closed caption service contains text tailored to the needs of beginning readers. When the flag is clear, the closed caption service is not so tailored. When the `digital_cc` flag is clear, this field has no meaning.

wide_aspect_ratio — A Boolean flag which indicates, when set, that the closed caption service is formatted for displays with 16:9 aspect ratio. When the flag is clear, the closed caption service is formatted for 4:3 display. When the `digital_cc` flag is clear, this field has no meaning.

6.9.3 Content Advisory Descriptor

The Content Advisory Descriptor is used to indicate, for a given event, ratings for any or all of the rating dimensions defined in the RRT (Rating Region Table). Ratings may be given for any or all of the defined regions, up to a maximum of 8 regions per event. An Event without a Content Advisory Descriptor indicates that the rating value for any rating dimension defined in any rating region is zero. The absence of ratings for a specific dimension is completely equivalent to having a zero-valued rating for such a dimension. The absence of ratings for a specific region implies the absence of ratings for all of the dimensions in the region. The absence of a Content Advisory Descriptor for a specific event implies the absence of ratings for all of the regions for the event.

A `content_advisory_descriptor()` may be present in the descriptor loop immediately following the `program_info_length` field in the `TS_program_map_section()` (as defined in ISO/IEC 13818-1 [8] Sections 2.4.4.8 and 2.4.4.9). This descriptor shall appear in the `descriptor()` loop for each EIT event that has one or more ratings.

The bit stream syntax for the Content Advisory Descriptor shall be as shown in Table 6.27.

Table 6.27 Stream Syntax for the Content Advisory Descriptor

Syntax	No. of Bits	Format
content_advisory_descriptor () {		
descriptor_tag	8	0x87
descriptor_length	8	uimsbf
reserved	2	'11'
rating_region_count	6	
for (i=0; i<rating_region_count; i++) {		
rating_region	8	uimsbf
rated_dimensions	8	uimsbf
for (j=0; j<rated_dimensions; j++) {		
rating_dimension_j	8	uimsbf
reserved	4	'1111'
rating_value	4	uimsbf
}		
rating_description_length	8	uimsbf
rating_description_text()	var	
}		
}		

descriptor_tag — This 8-bit unsigned integer shall have the value 0x87, identifying this descriptor as content_advisory_descriptor.

descriptor_length — This 8-bit unsigned integer specifies the length (in bytes) immediately following this field up to the end of this descriptor.

rating_region_count — A 6-bit unsigned integer value in the range 1 to 8 that indicates the number of rating region specifications to follow.

rating_region — An unsigned 8-bit integer that specifies the rating region for which the data in the bytes to follow is defined. The rating_region associates ratings data given here with data defined in a Ratings Region Table tagged with the corresponding rating region.

rated_dimensions — An 8-bit unsigned integer field that specifies the number of rating dimensions for which content advisories are specified for this event. The value of this field shall not be greater than the value specified by the field dimensions_defined in the corresponding RRT section.

rating_dimension_j — An 8-bit unsigned integer field specifies the dimension index into the RRT instance for the region specified by the field rating_region. These dimension indices shall be listed in numerical order; i.e., the value of rating_dimension_j+1 shall be greater than that of rating_dimension_j.

rating_value — A 4-bit field represents the rating value of the dimension specified by the field rating_dimension_j for the region given by rating_region.

rating_description_length — An 8-bit unsigned integer value in the range zero to 80 that represents the length of the rating_description_text() field to follow.

rating_description_text() — The rating description in the format of a multiple string structure (see Section 6.12). The rating_description display string shall be limited to 16 characters or less. The rating description text shall represent the program's rating in an abbreviated form suitable for on-screen display. The rating description text collects multidimensional text information into a single small text string. If "xxx" and "yyy" are abbreviated forms for rating values in two

dimensions, then “xxx-yyy” and “xxx (yyy)” are examples of possible strings represented in rating_description_text().

6.9.4 Extended Channel Name Descriptor

The extended channel name descriptor provides the long channel name for the virtual channel containing this descriptor.

The bit stream syntax for the extended channel name descriptor shall be as shown in Table 6.28.

Table 6.28 Bit Stream Syntax for the Extended Channel Name Descriptor

Syntax	No. of Bits	Format
extended_channel_name_descriptor () {		
descriptor_tag	8	0xA0
descriptor_length	8	uimsbf
long_channel_name_text()	var	
}		

descriptor_tag — This 8-bit unsigned integer shall have the value 0xA0, identifying this descriptor as extended_channel_name_descriptor().

descriptor_length — This 8-bit unsigned integer specifies the length (in bytes) immediately following this field up to the end of this descriptor.

long_channel_name_text() — The long channel name in the format of a multiple string structure (see Section 6.12).

6.9.5 Service Location Descriptor

This descriptor specifies the stream types, PID and language code for each elementary stream. An instance of this descriptor shall appear in the TVCT for each active channel. A service_location_descriptor() shall not be present for any inactive channel. When present, the service_location_descriptor() must be valid for the current event in the corresponding virtual channel.

Note that for cable, the information in the service_location_descriptor() is carried in the PMT with the syntax defined by Ref. [8].

The service_location_descriptor() shall indicate the same Elementary Stream data as the corresponding portion of the Program Map Table currently being transmitted. At minimum, the Service Location Descriptor shall include the video elementary stream (if one is present in the service), and all audio streams present in the service.

The bit stream syntax for the service_location_descriptor() shall be as shown in Table 6.29.

Table 6.29 Bit Stream Syntax for the Service Location Descriptor

Syntax	No. of Bits	Format
service_location_descriptor () {		
descriptor_tag	8	0xA1
descriptor_length	8	uimsbf
reserved	3	'111'
PCR_PID	13	uimsbf
number_elements	8	uimsbf
for (i=0;i<number_elements;i++) {		
stream_type	8	uimsbf
reserved	3	'111'
elementary_PID	13	uimsbf
ISO_639_language_code	8*3	uimsbf
}		
}		

descriptor_tag — This 8-bit unsigned integer shall have the value 0xA1, identifying this descriptor as service_location_descriptor().

descriptor_length — This 8-bit unsigned integer specifies the length (in bytes) immediately following this field up to the end of this descriptor.

PCR_PID — This is a 13 bit field indicating the PID of the Transport Stream packets which shall contain the PCR fields valid for the program specified by program_number. If no PCR is associated with a program definition for private streams then this field shall take the value of 0x1FFF. The value of PCR_PID shall be the same as the PCR_PID field of the TS_program_map_section() currently being transmitted for that program number.

number_elements — This 8-bit unsigned integer indicates the number of PIDs used for this program.

stream_type — This 8-bit unsigned integer field specifies the type of the elementary stream. Values for each stream_type, elementary_PID, and associated ISO 639 [5] language code shall be the same as those delivered in the corresponding ES_info loop of the TS_program_map_section() currently being transmitted. Informative Table 6.30 lists assignments for selected stream_type values.

Table 6.30 Selected Stream Type Assignments (Informative)

stream_type	Description
0x02	ITU-T Rec. H.262 ISO/IEC 13818-2 Video [9] or ISO/IEC 11172-2 [19] constrained parameter video stream
0x06	PES packets containing A/90 streaming, synchronized data
0x0B	DSM-CC sections containing A/90 asynchronous data
0x0D	DSM-CC addressable sections per A/90
0x14	DSM-CC sections containing non-streaming, synchronized data per A/90
0x81	Audio per ATSC A/53D [1] Annex B
0x95	Sections conveying A/90 [14] Data Service Table, Network Resources Table
0xC2	PES packets containing A/90 [14] streaming, synchronous data

elementary_PID — Packet Identifier for the elementary stream. The value for elementary_PID, stream_type, and the associated ISO 639 [5] language code shall be the same as those delivered in an ES_info loop of the TS_program_map_section() currently being transmitted.

ISO_639_language_code — This 3-byte (24 bits) field, in conformance with ISO 639.2/B [5], specifies the language used for the elementary stream. In case of no language specified for this elementary stream, e.g. video, each byte shall have the value 0x00. The value of the ISO_639_language_code field in the service_location_descriptor() shall be the same as the value in the corresponding ES_info loop of the TS_program_map_section() currently being transmitted. If no ISO_639_language_descriptor() is present in the ES_info loop for this Elementary Stream in the currently transmitted TS_program_map_section(), each byte of the ISO_639_language_code field shall be zero.

6.9.6 Time-Shifted Service Descriptor

This descriptor links one virtual channel with one or more virtual channels that carry the same programming on a time-shifted basis. The typical application is for Near Video On Demand (NVOD) services. The time_shifted_service_descriptor() shall be used only in the case that the time shift is constant across the time period covered by all EITs.

The base channel of a set of NVOD channels is the sole channel in that set that carries a time_shifted_service_descriptor() within its VCT entry. An NVOD base channel's EIT subtables shall be the same as that of a normal channel, except that EIT-0, in addition to its normal entries, shall list all events that have *expired* in the base channel's schedule until they have expired in all its child channels. NVOD child services derive their EIT information from that of the base channel by applying the time_shift specified in the base channels' time_shifted_service_descriptor(). ETMs for events expired in the base channel shall be carried on the PID listed for ETT-0 until they are no longer referenced by EIT-0.

Two example scenarios can be found in informative Annex D Section 7.

The bit stream syntax for the time_shifted_service_descriptor() shall be as shown in Table 6.31.

Table 6.31 Bit Stream Syntax for the Time Shifted Service Descriptor

Syntax	No. of Bits	Format
time_shifted_service_descriptor () {		
descriptor_tag	8	0xA2
descriptor_length	8	uimsbf
reserved	3	'111'
number_of_services	5	uimsbf
for (i=0;i<number_of_services;i++) {		
reserved	6	'111111'
time_shift	10	uimsbf
reserved	4	'1111'
major_channel_number	10	uimsbf
minor_channel_number	10	uimsbf
}		
}		

descriptor_tag — This 8-bit unsigned integer shall have the value 0xA2, identifying this descriptor as time_shifted_service_descriptor().

descriptor_length — This 8-bit unsigned integer specifies the length (in bytes) immediately following this field up to the end of this descriptor.

number_of_services — A 5-bit number in the range 1 to 20 that indicates the number of time-shifted services being defined here.

time_shift — A 10-bit number in the range 1 to 720 that represents the number of minutes the time-shifted service indicated by `major_channel_number` and `minor_channel_number` is time-shifted from the virtual channel associated with this descriptor.

major_channel_number — A 10-bit number in the range 1 to 999 that represents the “major” channel number associated with a time-shifted service.

minor_channel_number — A 10-bit number in the range 0 to 999 that, when non-zero, represents the “minor” or “sub-“ channel number of the virtual channel that carries a time-shifted service.

6.9.7 Component Name Descriptor

The `component_name_descriptor()` defines an optional textual name tag for any component of the service. The bit stream syntax for the `component_name_descriptor()` shall be as shown in Table 6.32.

Whenever a service includes two or more audio components labeled with the same `ISO_639_language_code` (in the ISO 639 Language Descriptor [5]) and `bsmod` (in the AC-3 Audio Descriptor), a unique `component_name_descriptor()` shall be placed into the descriptor loop immediately following `ES_info_length` in the `TS_program_map_section()` describing each such audio component.

Whenever a service includes an audio component whose bit stream mode (`bsmod`, as indicated in the AC-3 Audio Descriptor) is music and effects (ME) (`bsmod = 1`), and the component is a full service suitable for presentation (as indicated by the `full_svc` flag in the AC-3 Audio Descriptor being set) a unique `component_name_descriptor()` should be placed into the descriptor loop immediately following `ES_info_length` in the `TS_program_map_section()` of the `TS_program_map_section()` describing that component.

Table 6.32 Bit Stream Syntax for the Component Name Descriptor

Syntax	No. of Bits	Format
<code>component_name_descriptor() {</code>		
descriptor_tag	8	0xA3
descriptor_length	8	uimsbf
component_name_string()	var	
<code>}</code>		

descriptor_tag — This 8-bit unsigned integer shall have the value 0xA3, identifying this descriptor as `component_name_descriptor`.

descriptor_length — This 8-bit unsigned integer specifies the length (in bytes) immediately following this field up to the end of this descriptor.

component_name_string() — The name string in the format of a multiple string structure (see Section 6.12).

6.9.8 Stuffing Descriptor

For certain applications it is necessary to define a block of N bytes as a placeholder. The N bytes themselves are not to be processed or interpreted. The `stuffing_descriptor()` is specified for this purpose. The `stuffing_descriptor()` is simply a descriptor type for which the contents, as indicated by the `descriptor_length` field, are to be disregarded. The tag type for the stuffing descriptor is 0x80. The `stuffing_descriptor()` may appear where descriptors are allowed in any table defined in the PSIP.

6.9.9 Descriptors for Inactive Channels

The `service_location_descriptor()` shall not be present for inactive channels. Any other descriptors, if present, shall provide valid information about the inactive channel. The `extended_channel_name_descriptor()`, for example, can be used to provide the long-form channel name of the inactive channel.

6.9.10 DCC Departing Request Descriptor

This descriptor provides instructions for the actions to be performed by a DCCRR upon detection of a manual channel change requested by the viewer using the channel change controls on the DCCRR or a DCCRR remote control device, or any DCC term set that evaluates to cause a channel change, just prior to executing the channel change itself. This function shall be defeatable by the viewer within setup menu selections and shall default to “not enabled” if the viewer does not explicitly enable it. This descriptor may appear within the `dcc_additional_descriptor` loop if it is desired to associate a departing request with a manual channel change, and within the `dcc_test_descriptor` loop if it is desired to associate a departing request with a particular virtual channel's DCC event.

The bit stream syntax for the `dcc_departing_request_descriptor()` shall be as shown in Table 6.33.

Table 6.33 Bit Stream Syntax for the DCC Departing Request Descriptor

Syntax	No. of Bits	Format
<code>dcc_departing_request_descriptor () {</code>		
descriptor_tag	8	0xA8
descriptor_length	8	uimsbf
dcc_departing_request_type	8	uimsbf
dcc_departing_request_text_length	8	uimsbf
dcc_departing_request_text()	var	
<code>}</code>		

descriptor_tag — This 8-bit unsigned integer shall have the value 0xA8, identifying this descriptor as `dcc_departing_request_descriptor()`.

descriptor_length — This 8-bit unsigned integer specifies the length (in bytes) immediately following this field up to the end of this descriptor.

dcc_departing_request_type — This 8-bit unsigned integer specifies the type of the DCC departing request and shall have the values listed in Table 6.34.

Table 6.34 DCC Departing Request Type Assignments

dcc_departing_request_type	Meaning
0x00	Reserved.
0x01	Cancel any outstanding departing request type and immediately perform a channel change upon request by the viewer.
* 0x02	Display departing request text in a centered window for a minimum of 10 seconds prior to performing the channel change requested by the viewer or for a lesser amount of time if the viewer issues another channel change request or a "continue", "OK", "proceed", or equivalent command.
* 0x03	Display departing request text in a centered window indefinitely until viewer issues another channel change request or a "continue", "OK", "proceed", or equivalent command.
0x04-0xFF	Reserved

* Note: The above suggested behavior of the DCCRR's implementation of Departing Request types 0x02 and 0x03 are within the discretion of DCCRR manufacturers. The DCCRR's reaction to these commands may also be disabled by viewers through an interactive setup session.

dcc_departing_request_text_length — An 8-bit unsigned integer number that specifies the total length in bytes of the `dcc_departing_request_text()` field to follow.

dcc_departing_request_text() — The departing request window text in the format of a multiple string structure (see Section 6.12).

6.9.11 DCC Arriving Request Descriptor

This descriptor provides instructions for the actions to be performed by a DCCRR upon arrival at a newly changed channel. The arrival channel change request shall be executed within 30 seconds of arrival at, and detection within, the channel PSIP stream (this implies that, and is dependent upon, the descriptor being repeated or issued by the broadcaster and detected by the DCCRR in at least 30 second cycles). The `dcc_arriving_request_descriptor` shall only be located within the `dcc_test_descriptor` loop. This function shall be defeatable by the viewer within setup menu selections and shall default to "not enabled" if the viewer does not explicitly enable it.

The bit stream syntax for the `dcc_arriving_request_descriptor()` shall be as shown in Table 6.35.

Table 6.35 Bit Stream Syntax for the DCC Arriving Request Descriptor

Syntax	No. of Bits	Format
<code>dcc_arriving_request_descriptor () {</code>		
descriptor_tag	8	0xA9
descriptor_length	8	uimsbf
dcc_arriving_request_type	8	uimsbf
dcc_arriving_request_text_length	8	uimsbf
dcc_arriving_request_text()	var	
<code>}</code>		

descriptor_tag — This 8-bit unsigned integer shall have the value 0xA9, identifying this descriptor as `dcc_arriving_request_descriptor()`.

descriptor_length — This 8-bit unsigned integer specifies the length (in bytes) immediately following this field up to the end of this descriptor.

dcc_arriving_request_type — This 8-bit unsigned integer specifies the type of the DCC arriving request and shall have the values listed in Table 6.36.

Table 6.36 DCC Arriving Request Type Assignments

dcc_arriving_request_type	Meaning
0x00	Reserved
0x01*	Display arriving request text in a centered window for a minimum of 10 seconds after performing the channel change requested by the viewer, or for a less amount of time if the viewer issues a "continue", "OK", "proceed", or equivalent command.
0x02*	Display arriving request text in a centered window indefinitely after performing a channel change request requested by the viewer until viewer issues a "continue", "OK", "proceed", or equivalent command.
0x03-0xFF	Reserved

* Note: The above suggested behavior of the DCCRR's implementation of Arriving Request types 0x01 and 0x02 are within the discretion of DCCRR manufacturers. The DCCRR's reaction to these commands may also be disabled by viewers through an interactive setup session.

dcc_arriving_request_text_length — An 8-bit unsigned integer number that specifies the total length in bytes of the `dcc_arriving_request_text()` field to follow.

dcc_arriving_request_text() — The arriving request window text in the format of a multiple string structure (see Section 6.12).

6.9.12 Redistribution Control (RC) Descriptor

The purpose of the Redistribution Control descriptor is to convey a certain type of redistribution information held by the program rightsholder for audio, video, or data events. The descriptor's existence within the ATSC stream shall mean: "technological control of consumer redistribution is signaled."

The redistribution control information conveyed by the `rc_descriptor()` defined in Table 6.37 concerns the video/audio/data programming identified either by the `event_id` within the EIT or the `program_number` within the `TS_program_map_section()`.

For terrestrial broadcast transport, the `rc_descriptor()`, when transmitted, shall be present in both the EIT and `TS_program_map_section()`. For cable transport, the `rc_descriptor()`, when transmitted, shall be present in the `TS_program_map_section()`, and, when the EIT is carried, in the EIT.

The `rc_descriptor()`, when in the EIT, shall apply to a specific event associated with the Virtual Channel and the related MPEG-2 Program. It shall be placed within the descriptor loop after `descriptors_length` for the `event_id` for which this information is being signaled. The `rc_descriptor()`, shall be placed within the descriptor loop after `program_info_length` in the `TS_program_map_section()` for the `program_number` for which this information is being signaled. When the descriptor is placed in the `TS_program_map_section()`, it shall also be placed in the current event of EIT-0 for the Virtual Channel associated with the MPEG-2 Program; and it should be placed in the EIT for this event as far in advance as possible (i.e., minimally EIT-1, EIT-2, and EIT-3).

For data-only services¹⁴, the `rc_descriptor()` shall be placed in the DET (whose syntax and semantics are defined in ATSC A/90 Data Broadcasting Standard [14]) under the same provisions described for the EIT.

It is out of the scope of this standard to assert how any receiving device reacts when the `rc_descriptor` is present.

The bit stream syntax for the redistribution control descriptor shall be as shown in Table 6.37.

Table 6.37 Bit Stream Syntax for the Redistribution Control Descriptor

Syntax	No. of Bits	Format
<code>rc_descriptor() {</code>		
descriptor_tag	8	0xAA
descriptor_length	8	uimsbf
for (<code>i = 0; i < descriptor_length; i++</code>) {		
rc_information()	8	uimsbf
}		
}		

descriptor_tag — This 8-bit unsigned integer shall have the value 0xAA, identifying this descriptor as the `rc_descriptor()`.

descriptor_length — This 8-bit unsigned integer specifies the length (in bytes) immediately following this field through the last byte of this descriptor. The `descriptor_length` may, in the future, have a value other than 0x00. If the `descriptor_length` is not 0x00, optional information having a length of `descriptor_length` shall be contained within the `rc_information` field.

rc_information() — Optional additional redistribution control information that may be defined in the future.

6.9.13 Genre Descriptor

The Genre Descriptor provides genre, program type or category information for events. This descriptor may appear in the `descriptor()` loop for the given EIT event. The Genre Descriptor references entries in the Categorical Genre Code Assignments Table (Table 6.20), and may include references to expansions to that table provided by the DCC Selection Code Table (Sec. 6.8).

The Categorical Genre Code Assignments Table specifies two types of program attributes, a “basic” set and a “detail” set. The basic set characterizes the program at the highest level and defines the general category of the program. Each Genre Descriptor should include at least one attribute from the basic set.

The bit stream syntax for the Genre Descriptor shall be as shown in Table 6.38.

¹⁴ As defined in the ATSC A/90 Data Broadcast Standard [14].

Table 6.38 Stream Syntax for the Genre Descriptor

Syntax	No. of Bits	Format
genre_descriptor () {		
descriptor_tag	8	0xAB
descriptor_length	8	uimsbf
reserved	3	'111'
attribute_count	5	uimsbf
for (i=0; i< attribute_count; i++) {		
attribute	8	uimsbf
}		
}		

descriptor_tag — This 8-bit unsigned integer shall have the value 0xAB, identifying this descriptor as genre_descriptor().

descriptor_length — This 8-bit unsigned integer shall specify the length (in bytes) immediately following this field up to the end of this descriptor.

attribute_count — This 5-bit unsigned integer value shall be in the range 1 to 31 and shall indicate the number of attribute bytes to follow.

attribute — This 8-bit unsigned integer shall be in the range 0x01 to 0xFE and shall specify a basic genre or category type or detail attribute for the program, coded as a reference to the Categorical Genre Code Assignments Table (Table 6.20), including any expansions to that table as may be provided by the DCC Selection Code Table.

6.10 Multiple String Structure

This is a general data structure used specifically for text strings. Text strings appear as event titles, long channel names, the ETT messages, and RRT text items. The bit stream syntax for the Multiple String Structure shall be as shown in Table 6.39.

Table 6.39 Bit Stream Syntax for the Multiple String Structure

Syntax	No. of Bits	Format
multiple_string_structure () {		
number_strings	8	uimsbf
for (i= 0; i< number_strings; i++) {		
ISO_639_language_code	24	uimsbf
number_segments	8	uimsbf
for (j=0; j<number_segments; j++) {		
compression_type	8	uimsbf
mode	8	uimsbf
number_bytes	8	uimsbf
for (k= 0; k<number_bytes; k++)		
compressed_string_byte [k]	8	bslbf
}		
}		
}		

number_strings — This 8-bit unsigned integer field identifies the number of strings in the following data.

ISO_639_language_code — This 3-byte (24 bits) field, in conformance with ISO 639.2/B [5], specifies the language used for the i^{th} string.

number_segments — This 8-bit unsigned integer field identifies the number of segments in the following data. A specific mode is assigned for each segment.

compression_type — This 8-bit field identifies the compression type for the j^{th} segment. Allowed values for this field shall be as shown in Table 6.40. Compression types 0x01 and 0x02 shall be restricted for use with text mode 0x00.

Table 6.40 Compression Types

compression_type	Compression Method
0x00	No compression
0x01	Huffman coding using standard encode/decode tables defined in Table C.4 and C.5 in Annex C.
0x02	Huffman coding using standard encode/decode tables defined in Table C.6 and C.7 in Annex C.
0x03 to 0xAF	reserved
0xB0 to 0xFF	Used in other systems

mode — An 8-bit value representing a mode to be used to interpret the segment's contents as encoded character (textual) data. Allowed values for this field are shown in Table 6.41. In the case that a decoder does not support a mode, then the string entry that includes that mode within the multiple string structure shall be ignored. When using modes 0x01-0x06, 0x09-0x0E, 0x10, 0x20-0x27, 0x30-0x33, the value of `compression_type` shall be 0x00 (no compression).

When mode values 0x01-0x06, 0x09-0x0E, 0x10, 0x20-0x27, or 0x30-0x33 are used, the segment's bytes shall represent the least significant 8-bits of a sequence of 16-bit Unicode code values where the most significant 8-bits of these code values is implied by the mode value itself. For example, the sequence of Unicode code values [0x0E50, 0x0E51, 0x0E52] may be represented by a single segment with mode 0x0E and with segment string bytes [0x50, 0x51, 0x52]. These modes provide a simple form of run-length encoding for a sequence of 16-bit Unicode code values.

See Unicode Technical Report #6 [11] for a detailed specification of the encoding of mode 0x3E.

When using mode 0x3F, the UTF-16 representation of Unicode character data shall apply. UTF-16 is a sequence of 16-bit Unicode code values where each code value either (1) designates a particular standardized or user private character; or (2) forms either the low or high part of a surrogate pair that collectively designates a particular standardized or user private character. See The Unicode Standard [10] for precise specification of UTF-16. When using mode 0x3F, 16-bit Unicode code values comprising UTF-16 code elements shall be encoded as unsigned integers, most significant bit first (`uimsbf`).

It is recommended that the representation of strings not covered by mode 0x00 make use of either modes 0x3E (preferred) or 0x3F (alternate) according to whichever mode results in the fewest octets.

number_bytes — This 8-bit unsigned integer field identifies the number of bytes that follows.

compressed_string_byte[k] — The k^{th} byte of the j^{th} segment. This field shall occupy an integral number of octets and shall be padded as necessary to satisfy this requirement. The interpretation of these octets shall be in accordance with the segment's mode and `compression_type`.

Table 6.41 Modes

Mode	Meaning
0x00	Select Unicode Code Range 0x0000 – 0x00FF
0x01	Select Unicode Code Range 0x0100 – 0x01FF
0x02	Select Unicode Code Range 0x0200 – 0x02FF
0x03	Select Unicode Code Range 0x0300 – 0x03FF
0x04	Select Unicode Code Range 0x0400 – 0x04FF
0x05	Select Unicode Code Range 0x0500 – 0x05FF
0x06	Select Unicode Code Range 0x0600 – 0x06FF
0x07-0x08	Reserved
0x09	Select Unicode Code Range 0x0900 – 0x09FF
0x0A	Select Unicode Code Range 0x0A00 – 0x0AFF
0x0B	Select Unicode Code Range 0x0B00 – 0x0BFF
0x0C	Select Unicode Code Range 0x0C00 – 0x0CFF
0x0D	Select Unicode Code Range 0x0D00 – 0x0DFF
0x0E	Select Unicode Code Range 0x0E00 – 0x0EFF
0x0F	Select Unicode Code Range 0x0F00 – 0x0FFF
0x10	Select Unicode Code Range 0x1000 – 0x10FF
0x11-0x1F	Reserved
0x20	Select Unicode Code Range 0x2000 – 0x20FF
0x21	Select Unicode Code Range 0x2100 – 0x21FF
0x22	Select Unicode Code Range 0x2200 – 0x22FF
0x23	Select Unicode Code Range 0x2300 – 0x23FF
0x24	Select Unicode Code Range 0x2400 – 0x24FF
0x25	Select Unicode Code Range 0x2500 – 0x25FF
0x26	Select Unicode Code Range 0x2600 – 0x26FF
0x27	Select Unicode Code Range 0x2700 – 0x27FF
0x28-0x2F	Reserved
0x30	Select Unicode Code Range 0x3000 – 0x30FF
0x31	Select Unicode Code Range 0x3100 – 0x31FF
0x32	Select Unicode Code Range 0x3200 – 0x32FF
0x33	Select Unicode Code Range 0x3300 – 0x33FF
0x34-0x3D	Reserved
0x3E	Select Standard Compression Scheme for Unicode (SCSU)
0x3F	Select Unicode, UTF-16 Form
0x40-0x41	Assigned to ATSC standard for Taiwan
0x42-0x47	Reserved for future ATSC use
0x48	Assigned to ATSC standard for South Korea
0x49-0xDF	Reserved for future ATSC use
0xE0-0xFE	Used in other systems
0xFF	Not applicable

7. PSIP STD MODEL

7.1 Buffer Model for Terrestrial Broadcast

Table 7.1 lists the maximum cycle time for all PSIP tables, except EITs and ETTs. Table 7.2 lists the maximum transmission rate for PSIP packet streams according to their PIDs. The recommended maximum cycle time for EIT-0 is 500 ms.

Table 7.1 Maximum Cycle Time for the STT, MGT, VCT and RRT

Table	STT	MGT	VCT	RRT
Cycle time (ms)	1000	150	400	60000

Table 7.2 Maximum Rate for Each PSIP Packet Stream

PID	base_PID	EIT_PID	ETT_PID
Rate (bps)	250,000	250,000	250,000

For terrestrial broadcast applications the following constraints apply:

- In terrestrial broadcast applications, the PSIP elementary streams identified by Transport Stream packets with PID 0x1FFB (base_PID), EIT PIDs and ETT PIDs shall adhere to an STD model with the following parameters:
- sb_leak_rate shall be 625 (indicating a leak rate of 250,000 bps)
- sb_size shall be 1024 (indicating a smoothing buffer size of 1024 bytes)

7.2 Buffer Model for Cable

Transmission rates for cable will be standardized by the SCTE.

7.3 Buffer Model Considerations to Support Directed Channel Change for Terrestrial Broadcast

The maximum cycle time for the Directed Channel Change Table (DCCT) is recommended not to exceed 150 ms. while a DCC request is in progress. The maximum cycle time for the DCCT is recommended not to exceed 400 ms. within 2 seconds of an impending DCC request. It is recommended that there be no maximum cycle time for the DCCT if there are no impending DCC requests.

The maximum cycle time for the Directed Channel Change Selection Code Table (DCCSCT) is recommended not to exceed 1 hour.

Annex A: Daylight Savings Time Control (Normative)

In order to convert GPS into local time, the receiver needs to store a time offset (from GPS to local time) in local memory and an indicator as to whether daylight savings is observed. These two quantities can be obtained from the user interface (indicating time zone and daylight savings observance) or from the conditional access system, if present, and stored in non-volatile receiver memory.

Since there is a common time (GPS) transmitted in the PSIP, there needs to be a mechanism to indicate when the receiver should switch into (or out of) daylight savings time at the appropriate local time. Once all the receivers have transitioned at their local times, the entire system can be shifted into daylight savings time. This is accomplished by appropriate setting of the `daylight_savings` in the STT. The structure of daylight savings time control shall be as shown in Table A1, and the basic use of daylight savings fields through the year shall be as shown in Table A2.

Table A1 Structure of Daylight Savings Time Control

Syntax	No. of Bits	Format
<code>daylight_savings () {</code>		
DS_status	1	bslbf
reserved	2	'11'
DS_day_of_month	5	uimsbf
DS_hour	8	uimsbf
<code>}</code>		

DS_status — This bit indicate the status of daylight savings.

DS_status = '0': Not in daylight savings time.

DS_status = '1': In daylight savings time.

DS_day_of_month — This 5-bit unsigned integer field indicates the local day of the month on which the transition into or out of daylight savings time is to occur (1–31).

DS_hour — This 8-bit unsigned integer field indicates the local hour at which the transition into or out of daylight savings time is to occur (0–18). This usually occurs at 2 a.m. in the U.S.

Table A2 Basic Use of Daylight Savings Fields Through the Year

Conditions	DS_status	DS_day_of_month	DS_hour
At the beginning of the year (January) daylight savings is off. This is the status of the fields until:	0	0	0
When the transition into daylight savings time is within less than one month, the DS_day_of_month field takes the value day_in, and the DS_hour field takes the value hour_in. The DS_status bit is 0 indicating it is not yet daylight savings time. (The transition is to occur on the day_in day of the month at hour=hour_in; for example, if the transition were on April 15 at 2 a.m., then day_in=15 and hour_in=2)	0	day_in	hour_in
After all time zone daylight transitions (within the span of the network) have occurred, the DS_status bit takes the value 1, indicating that daylight savings time is on. The DS_day_of_month field and the DS_hour field take the value 0. (In the U.S., this transition has to occur no later than 7 p.m. Pacific Time on the day day_in). This is the status of the fields until:	1	0	0
When the transition out of daylight savings time is within less than one month, the DS_day_of_month field takes the value day_out, and the DS_hour field takes the value hour_out. The DS_status bit is 1 indicating it is still daylight savings time. (The transition is to occur on the day_out day of the month at hour=hour_out; for example, if the transition were on October 27 at 2 a.m., then day_out=27 and hour_out=2)	1	day_out	hour_out
After all time zones (within the span of the network) have shifted out of daylight savings time, the DS_status bit takes the value 0, indicating that daylight savings time is off. The DS_day_of_month field and the DS_hour field take the value 0. (In the U.S., this transition has to occur no later than 7 p.m. Pacific Time on the day day_out). This finishes the cycle.	0	0	0

Annex B: Additional Constraints on Virtual Channel Table For the U.S. (Normative)

1. ASSIGNMENT OF MAJOR CHANNEL NUMBER VALUES FOR TERRESTRIAL BROADCAST IN THE U.S.

The assignment of `major_channel_number` values in the U.S. shall be based on the rules below.

- 1) For broadcasters with existing NTSC licenses, the `major_channel_number` for the existing NTSC channels, as well as the digital virtual channels, controlled by the broadcaster, shall be set to the current NTSC RF channel number. E.g., assume a broadcaster who has an NTSC broadcast license for RF channel 13 is assigned RF channel 39 for digital ATSC broadcast. That broadcaster is required to use `major_channel_number` 13 for identification of the analog NTSC channel on RF channel 13, as well as the digital virtual channels it is controlling on RF channel 39.
- 2) For a new broadcaster without an existing NTSC license, the `major_channel_number` for the digital virtual channels controlled by the broadcaster shall be set to the FCC assigned RF channel number for ATSC digital TV broadcast. E.g., assume a broadcaster who currently has no NTSC broadcast license applies and receives a license for digital ATSC broadcast on RF channel 49. That broadcaster is required to use `major_channel_number` 49 for identification of the digital virtual channels that it is controlling on RF channel 49.
- 3) If during or at the end of the transition period, the RF channel assigned to a broadcaster for digital ATSC broadcast is changed for any reason, the `major_channel_number` used by that broadcaster shall not change.
- 4) If, after the transition, a previously used NTSC RF channel in a market is assigned to a newly-licensed DTV broadcaster in that market, the newly-licensed DTV broadcaster shall use, as his `major_channel_number`, the number of the originally allocated DTV RF channel being used by the previous NTSC licensee of the assigned channel.
- 5) If a broadcaster owns or controls broadcast licenses for two or more different RF channels having overlapping service areas, he may use a common `major_channel_number` for all services on all channels. He may choose the `major_channel_number` as determined above for any one of the RF channels. The values in the `minor_channel_number` fields must be partitioned to insure that there is no duplication of the two-part channel number in the DTV service area, including the overlapping DTV service areas of other broadcasters using that same `major_channel_number`.
- 6) The two-part channel numbers for other broadcasts may be included in the DTV transport stream, provided that the `channel_TSID` and `source_id` are exactly associated with the two-part channel number combinations used by the referenced broadcaster and there is no duplication with those used by any broadcaster whose DTV service¹⁵ area overlaps with the emitting station's DTV service¹⁶ area.

¹⁵ CFR 47 73.622(e) [13]

¹⁶ CFR 47 73.622(e) [13]

- 7) A broadcaster may include in the transmitted multiplex programming originating from a different licensed broadcaster and use the major/minor channel numbers of the original broadcast if the major/minor channel number combinations are coordinated in the local broadcast area to avoid conflicts. The coordination process is beyond the scope of this document.
- 8) The provisions listed above assign `major_channel_number` values 2 through 69 uniquely to broadcasters licensed to broadcast Digital ATSC signals and guarantee that the two-part channel number combinations used by a broadcaster will be different from those used by any other broadcaster with an overlapping DTV service¹⁷ area.
- 9) Values for `major_channel_number` from 70 to 99 may be used to identify groups of digital services carried in an ATSC multiplex that the broadcaster wishes to be identified by a different major channel number. Values 70 through 99 must be unique in each potential receiving location or the receiver will not be able to correctly select such services. For example a local broadcaster transmitting community college lectures in its bit stream may want to use a `major_channel_number` different than its own `major_channel_number` for the virtual channel carrying the lectures. The assessment of the feasibility of using this capability, as well as the coordination process for assignment of these `major_channel_number` values is beyond the scope of this document.
- 10) For a translated signal, the major/minor channel numbers shall remain the same as the original broadcast station unless the major channel conflicts with a broadcaster operating in the service area of the translator. In that case, the translator shall change the major number to a non-conflicting number.

2. REQUIREMENT TO TRANSMIT ANALOG TRANSMISSION SIGNAL ID

Broadcasters which reference an NTSC signal by inserting a `channel_TSID` in a VCT shall cause insertion of an analog Transmission Signal ID within the VBI of each referenced NTSC signal per CEA-608-B [3]. Refer to Annex D Section 9 for a discussion of the use of the analog Transmission Signal ID.

¹⁷ CFR 47 73.622(e) [13]

Annex C: Standard Huffman Tables for Text Compression¹⁸ (Normative)

1. SCOPE

This Annex describes the compression method adopted for the transmission of English-language text strings in PSIP. The method distinguishes two types of text strings: titles and program descriptions. For each of these types, Huffman tables are defined based on 1st-order conditional probabilities. Section 3 defines standard Huffman encode and decode tables optimized for English-language text such as that typically found in program titles. Section 4 defines Huffman encode and decode tables optimized for English-language text such as that typically found in program descriptions. Receivers supporting the English language are expected to support decoding of text using either of these two standard Huffman compression tables.

The encode tables provide necessary and sufficient information to build the Huffman trees that need to be implemented for decoding. The decode tables described in Tables C5 and C7 are a particular mapping of those trees into a numerical array suitable for storage. This array can be easily implemented and used with the decoding algorithm. However, the user is free to design its own decoding tables as long as they follow the Huffman trees and rules defined in this Annex.

2. CHARACTER SET DEFINITION

This compression method supports the full ISO/IEC 8859-1 [7] (Latin-1) character set, although only characters in the ASCII range (character codes 1 to 127) can be compressed. The following characters have special definitions:

Table C1 Characters with Special Definitions

Character	Value (Decimal)	Meaning
String Terminate (ASCII Null)	0	The <i>Terminate</i> character is used to terminate strings. The Terminate character is appended to the string in either compressed or uncompressed form. The first encoded character in a compressed string is encoded/decoded from the Terminate sub-tree. In other words, when encoding or decoding the first character in a compressed string, assume that the previous character was a Terminate character.
Order-1 Escape (ASCII ESC)	27	Used to escape from first-order context to uncompressed context. The character which follows the Escape character is uncompressed.

2.1 First Order Escape

The order-1 Huffman trees are *partial*, that is, codes are not defined for every possible character sequence. For example, the standard decode tables do not contain codes for the character sequence *qp*. When uncompressed text contains a character sequence which is not defined in the decode table, the order-1 escape character is used to escape back to the uncompressed context. Uncompressed symbols are coded as 8-bit ASCII (Latin I). For example, the character sequence *qpa* would be coded with *compressed q*, *compressed ESC*, *uncompressed p*, *compressed a*.

¹⁸ Tables C4 through C7 are © 1997 General Instrument Corporation. Unlimited use in conjunction with this ATSC standard is granted on a royalty-free basis by General Instrument Corporation. All other rights are reserved.

First-order escape rules for compressed strings:

- Any character which follows a first-order escape character is an uncompressed (8-bit) character. (Any character which follows an uncompressed escape character is compressed).
- Characters (128 .. 255) cannot be compressed.
- Any character which follows a character from the set (128 .. 255) is uncompressed.

2.2 Decode Table Data Structures

Decode tables have two sections:

- **Tree Root Offset List:** Provides the table offsets, in *bytes* from the start of the decode table, for the roots of the 128 first-order decode trees. The list is contained in bytes (0 .. 255) of the decode table, and is defined by the first “for” loop in Table C1.
- **Order-1 Decode Trees:** Each and every character in the range (0 .. 127) has a corresponding first-order decode tree. For example, if the previous character was "s", then the decoder would use the "s" first-order decode tree (decode tree #115) to decode the next character (ASCII "s" equals 115 decimal). These 128 decode trees are delimited by the second “for” loop in Table C2.

Decode tables have the following format:

Table C2 Decode Table Format

Syntax	No. of Bits	Format
<pre> decode_table() { for (i==0; i<128; i++) { byte_offset_of_char_i_tree_root } for (i==0; i<128; i++) { character_i_order_1_tree() } } </pre>	16	uimsbf
	8*M	

Note that even though the ISO Latin-1 character set supports up to 256 characters, only the first 128 characters may be represented in compressed form.

2.2.1 Tree Root Byte Offsets

byte_offset_of_character_i_tree_root — A 16-bit unsigned integer specifying the location, in bytes from the beginning of the decode table, of the root for the i^{th} character’s order-1 tree.

2.2.2 Order-1 Decode Trees

Order-1 decode trees are binary trees. The roots of the decode trees are located at the table offsets specified in the tree root offset list. The left and right children of a given node are specified as *word* offsets from the root of the tree (a *word* is equivalent to two bytes).

Decode trees have the format given in Table C3.

Table C3 Decode Tree Format

Syntax	No. of Bits	Format
<pre> character_i_order_1_tree() { for (j==0; j<N; j++) { left_child_word_offset_or_char_leaf right_child_word_offset_or_char_leaf } } </pre>	8	uimsbf
	8	uimsbf

left_child_word_offset_or_char_leaf — An 8-bit unsigned integer number with the following interpretation: If the highest bit is cleared (i.e., bit 7 is zero), the number specifies the offset, in words, of the left child from the root of the order-1 decode tree; if the highest bit is set (bit 7 is one), the lower 7 bits give the code (e.g., in ASCII) for a leaf character.

right_child_word_offset_or_char_leaf — An 8-bit unsigned integer number with the following interpretation: If the highest bit is cleared (i.e., bit 7 is zero), the number specifies the offset, in words, of the right child from the root of the order-1 decode tree; if the highest bit is set (bit 7 is one), the lower 7 bits give the code (e.g., in ASCII) for a leaf character.

It can be seen from Figure F3 (Annex F) that each node (corresponding to one iteration of the for-loop) has a byte for the left child or character, and a byte for the right child or character.

Characters are *leaves* of the order-1 decode trees, and are differentiated from intermediate nodes by the byte's most significant bit. When the most significant bit is set, the byte is a character leaf. When the most significant bit is not set, the byte contains the tabular word offset of the child node.

3. STANDARD COMPRESSION TYPE 1 ENCODE/DECODE TABLES

The following encode/decode tables are optimized for English-language program title text. These tables correspond to `multiple_string_structure()` with `compression_type` value 0x01, and a mode equal to 0xFF.

Table C4 English-language Program Title Encode Table

Prior Symbol: 0 Symbol: 27 Code: 11001011	Prior Symbol: '' Symbol: '9' Code: 000000000	Prior Symbol: '' Symbol: 'R' Code: 1001
Prior Symbol: 0 Symbol: '\$' Code: 1100101011	Prior Symbol: '' Symbol: 'A' Code: 10111	Prior Symbol: '' Symbol: 'S' Code: 1010
Prior Symbol: 0 Symbol: '2' Code: 011010010	Prior Symbol: '' Symbol: 'B' Code: 0010	Prior Symbol: '' Symbol: 'T' Code: 1011
Prior Symbol: 0 Symbol: '4' Code: 1100101010	Prior Symbol: '' Symbol: 'C' Code: 1100	Prior Symbol: '' Symbol: 'U' Code: 1100
Prior Symbol: 0 Symbol: '7' Code: 011010011	Prior Symbol: '' Symbol: 'D' Code: 11100	Prior Symbol: '' Symbol: 0 Code: 111
Prior Symbol: 0 Symbol: 'A' Code: 0111	Prior Symbol: '' Symbol: 'E' Code: 011010	Prior Symbol: '' Symbol: 27 Code: 101
Prior Symbol: 0 Symbol: 'B' Code: 1001	Prior Symbol: '' Symbol: 'F' Code: 10011	Prior Symbol: '' Symbol: '' Code: 0
Prior Symbol: 0 Symbol: 'C' Code: 1011	Prior Symbol: '' Symbol: 'G' Code: 00001	Prior Symbol: '' Symbol: '' Code: 110
Prior Symbol: 0 Symbol: 'D' Code: 11011	Prior Symbol: '' Symbol: 'H' Code: 10101	Prior Symbol: '' Symbol: 'I' Code: 10010
Prior Symbol: 0 Symbol: 'E' Code: 10001	Prior Symbol: '' Symbol: 'I' Code: 111111	Prior Symbol: '' Symbol: 'S' Code: 1000
Prior Symbol: 0 Symbol: 'F' Code: 11000	Prior Symbol: '' Symbol: 'J' Code: 111110	Prior Symbol: '' Symbol: 'U' Code: 10011
Prior Symbol: 0 Symbol: 'G' Code: 11100	Prior Symbol: '' Symbol: 'K' Code: 010011	Prior Symbol: '' Symbol: 27 Code: 1
Prior Symbol: 0 Symbol: 'H' Code: 11111	Prior Symbol: '' Symbol: 'L' Code: 11110	Prior Symbol: '0' Symbol: 0 Code: 01
Prior Symbol: 0 Symbol: 'I' Code: 10000	Prior Symbol: '' Symbol: 'M' Code: 0101	Prior Symbol: '0' Symbol: 27 Code: 001
Prior Symbol: 0 Symbol: 'J' Code: 01100	Prior Symbol: '' Symbol: 'N' Code: 10110	Prior Symbol: '0' Symbol: '' Code: 10
Prior Symbol: 0 Symbol: 'K' Code: 1100110	Prior Symbol: '' Symbol: 'O' Code: 011011	Prior Symbol: '0' Symbol: '' Code: 000
Prior Symbol: 0 Symbol: 'L' Code: 11101	Prior Symbol: '' Symbol: 'P' Code: 11101	Prior Symbol: '0' Symbol: '0' Code: 11
Prior Symbol: 0 Symbol: 'M' Code: 1010	Prior Symbol: '' Symbol: 'Q' Code: 100100011	Prior Symbol: '1' Symbol: 0 Code: 010
Prior Symbol: 0 Symbol: 'N' Code: 0011	Prior Symbol: '' Symbol: 'R' Code: 10100	Prior Symbol: '1' Symbol: 27 Code: 101
Prior Symbol: 0 Symbol: 'O' Code: 011011	Prior Symbol: '' Symbol: 'S' Code: 1101	Prior Symbol: '1' Symbol: '' Code: 010
Prior Symbol: 0 Symbol: 'P' Code: 11110	Prior Symbol: '' Symbol: 'T' Code: 1000	Prior Symbol: '1' Symbol: '0' Code: 111
Prior Symbol: 0 Symbol: 'Q' Code: 01101000	Prior Symbol: '' Symbol: 'U' Code: 1001001	Prior Symbol: '1' Symbol: '1' Code: 100
Prior Symbol: 0 Symbol: 'R' Code: 11010	Prior Symbol: '' Symbol: 'V' Code: 1001011	Prior Symbol: '1' Symbol: '2' Code: 101
Prior Symbol: 0 Symbol: 'S' Code: 000	Prior Symbol: '' Symbol: 'W' Code: 0011	Prior Symbol: '1' Symbol: '9' Code: 00
Prior Symbol: 0 Symbol: 'T' Code: 010	Prior Symbol: '' Symbol: 'X' Code: 000000010	Prior Symbol: '2' Symbol: 0 Code: 11
Prior Symbol: 0 Symbol: 'U' Code: 0110101	Prior Symbol: '' Symbol: 'Y' Code: 000001	Prior Symbol: '2' Symbol: '27' Code: 10
Prior Symbol: 0 Symbol: 'V' Code: 1100111	Prior Symbol: '' Symbol: 'Z' Code: 00000011	Prior Symbol: '2' Symbol: '0' Code: 01
Prior Symbol: 0 Symbol: 'W' Code: 0010	Prior Symbol: '' Symbol: 'a' Code: 01100	Prior Symbol: '2' Symbol: '1' Code: 000
Prior Symbol: 0 Symbol: 'Y' Code: 1100100	Prior Symbol: '' Symbol: 'b' Code: 10010101	Prior Symbol: '2' Symbol: '' Code: 001
Prior Symbol: 0 Symbol: 'Z' Code: 110010100	Prior Symbol: '' Symbol: 'c' Code: 01000000	Prior Symbol: '3' Symbol: 0 Code: 0
Prior Symbol: 1 Symbol: 27 Code: 1	Prior Symbol: '' Symbol: 'd' Code: 01000011	Prior Symbol: '3' Symbol: 27 Code: 11
Prior Symbol: 2 Symbol: 27 Code: 1	Prior Symbol: '' Symbol: 'e' Code: 0000000011	Prior Symbol: '3' Symbol: '0' Code: 10
Prior Symbol: 3 Symbol: 27 Code: 1	Prior Symbol: '' Symbol: 'f' Code: 10010000	Prior Symbol: '4' Symbol: 27 Code: 0
Prior Symbol: 4 Symbol: 27 Code: 1	Prior Symbol: '' Symbol: 'i' Code: 010010	Prior Symbol: '4' Symbol: '8' Code: 1
Prior Symbol: 5 Symbol: 27 Code: 1	Prior Symbol: '' Symbol: 'l' Code: 100100010	Prior Symbol: '5' Symbol: '27' Code: 1
Prior Symbol: 6 Symbol: 27 Code: 1	Prior Symbol: '' Symbol: 'o' Code: 0001	Prior Symbol: '6' Symbol: 27 Code: 1
Prior Symbol: 7 Symbol: 27 Code: 1	Prior Symbol: '' Symbol: 't' Code: 0111	Prior Symbol: '7' Symbol: 27 Code: 0
Prior Symbol: 8 Symbol: 27 Code: 1	Prior Symbol: '' Symbol: 0 Code: 1	Prior Symbol: '7' Symbol: '0' Code: 1
Prior Symbol: 9 Symbol: 27 Code: 1	Prior Symbol: '' Symbol: 27 Code: 01	Prior Symbol: '8' Symbol: 27 Code: 0
Prior Symbol: 10 Symbol: 27 Code: 1	Prior Symbol: '' Symbol: '' Code: 00	Prior Symbol: '8' Symbol: '' Code: 1
Prior Symbol: 11 Symbol: 27 Code: 1	Prior Symbol: '' Symbol: 27 Code: 1	Prior Symbol: '9' Symbol: '27' Code: 11
Prior Symbol: 12 Symbol: 27 Code: 1	Prior Symbol: '#' Symbol: 27 Code: 1	Prior Symbol: '9' Symbol: '0' Code: 01
Prior Symbol: 13 Symbol: 27 Code: 1	Prior Symbol: '\$' Symbol: 27 Code: 1	Prior Symbol: '9' Symbol: '1' Code: 100
Prior Symbol: 14 Symbol: 27 Code: 1	Prior Symbol: '\$' Symbol: '1' Code: 0	Prior Symbol: '9' Symbol: '\$' Code: 101
Prior Symbol: 15 Symbol: 27 Code: 1	Prior Symbol: '%' Symbol: 27 Code: 1	Prior Symbol: '9' Symbol: '9' Code: 00
Prior Symbol: 16 Symbol: 27 Code: 1	Prior Symbol: '&' Symbol: 27 Code: 0	Prior Symbol: '' Symbol: 27 Code: 0
Prior Symbol: 17 Symbol: 27 Code: 1	Prior Symbol: '&' Symbol: '' Code: 1	Prior Symbol: '' Symbol: '' Code: 1
Prior Symbol: 18 Symbol: 27 Code: 1	Prior Symbol: '' Symbol: 27 Code: 011	Prior Symbol: '' Symbol: 27 Code: 1
Prior Symbol: 19 Symbol: 27 Code: 1	Prior Symbol: '' Symbol: '' Code: 010	Prior Symbol: '<' Symbol: 27 Code: 1
Prior Symbol: 20 Symbol: 27 Code: 1	Prior Symbol: '' Symbol: '9' Code: 0001	Prior Symbol: '= ' Symbol: 27 Code: 1
Prior Symbol: 21 Symbol: 27 Code: 1	Prior Symbol: '' Symbol: 'd' Code: 0000	Prior Symbol: '>' Symbol: 27 Code: 1
Prior Symbol: 22 Symbol: 27 Code: 1	Prior Symbol: '' Symbol: 's' Code: 1	Prior Symbol: '?' Symbol: 0 Code: 1
Prior Symbol: 23 Symbol: 27 Code: 1	Prior Symbol: '' Symbol: 't' Code: 001	Prior Symbol: '? ' Symbol: 27 Code: 0
Prior Symbol: 24 Symbol: 27 Code: 1	Prior Symbol: '(' Symbol: 27 Code: 1	Prior Symbol: '@' Symbol: 27 Code: 1
Prior Symbol: 25 Symbol: 27 Code: 1	Prior Symbol: ')' Symbol: 27 Code: 1	Prior Symbol: 'A' Symbol: 27 Code: 00010
Prior Symbol: 26 Symbol: 27 Code: 1	Prior Symbol: '' Symbol: 27 Code: 00	Prior Symbol: 'A' Symbol: '' Code: 010
Prior Symbol: 27 Symbol: 27 Code: 1	Prior Symbol: '' Symbol: 'A' Code: 01	Prior Symbol: 'A' Symbol: '' Code: 1101000
Prior Symbol: 28 Symbol: 27 Code: 1	Prior Symbol: '' Symbol: 'H' Code: 10	Prior Symbol: 'A' Symbol: '' Code: 1101001
Prior Symbol: 29 Symbol: 27 Code: 1	Prior Symbol: '' Symbol: 'S' Code: 11	Prior Symbol: 'A' Symbol: '' Code: 1101010
Prior Symbol: 30 Symbol: 27 Code: 1	Prior Symbol: '' Symbol: '+' Code: 1	Prior Symbol: 'A' Symbol: 'B' Code: 110110
Prior Symbol: 31 Symbol: 27 Code: 1	Prior Symbol: '' Symbol: 27 Code: 0	Prior Symbol: 'A' Symbol: 'b' Code: 110010
Prior Symbol: '' Symbol: 27 Code: 10010100	Prior Symbol: '' Symbol: '' Code: 1	Prior Symbol: 'A' Symbol: 'c' Code: 01100
Prior Symbol: '' Symbol: '&' Code: 010001	Prior Symbol: '' Symbol: 27 Code: 01	Prior Symbol: 'A' Symbol: 'd' Code: 001
Prior Symbol: '' Symbol: '' Code: 010000100	Prior Symbol: '' Symbol: '' Code: 111	Prior Symbol: 'A' Symbol: 'f' Code: 01101
Prior Symbol: '' Symbol: '' Code: 00000001	Prior Symbol: '' Symbol: '' Code: 1101	Prior Symbol: 'A' Symbol: 'g' Code: 011110
Prior Symbol: '' Symbol: '1' Code: 010000101	Prior Symbol: '' Symbol: '1' Code: 1000	Prior Symbol: 'A' Symbol: 'i' Code: 110011
Prior Symbol: '' Symbol: '2' Code: 00000010	Prior Symbol: '' Symbol: 'A' Code: 001	Prior Symbol: 'A' Symbol: 'l' Code: 100
Prior Symbol: '' Symbol: '3' Code: 01000001	Prior Symbol: '' Symbol: 'M' Code: 000	Prior Symbol: 'A' Symbol: 'm' Code: 111

Prior Symbol: 'A' Symbol: 'n' Code: 101	Prior Symbol: 'H' Symbol: 'i' Code: 1111	Prior Symbol: 'P' Symbol: 'u' Code: 01101
Prior Symbol: 'A' Symbol: 'p' Code: 110111	Prior Symbol: 'H' Symbol: 'o' Code: 0	Prior Symbol: 'P' Symbol: 'y' Code: 011000
Prior Symbol: 'A' Symbol: 'r' Code: 0000	Prior Symbol: 'H' Symbol: 'u' Code: 111000	Prior Symbol: 'Q' Symbol: '27' Code: 00
Prior Symbol: 'A' Symbol: 's' Code: 00011	Prior Symbol: 'I' Symbol: '0' Code: 1000	Prior Symbol: 'Q' Symbol: 'V' Code: 01
Prior Symbol: 'A' Symbol: 't' Code: 011111	Prior Symbol: 'I' Symbol: '27' Code: 1001	Prior Symbol: 'Q' Symbol: 'u' Code: 1
Prior Symbol: 'A' Symbol: 'u' Code: 11000	Prior Symbol: 'I' Symbol: ':' Code: 11110	Prior Symbol: 'R' Symbol: '27' Code: 1010001
Prior Symbol: 'A' Symbol: 'v' Code: 1101011	Prior Symbol: 'I' Symbol: '::' Code: 111110	Prior Symbol: 'R' Symbol: 'a' Code: 101
Prior Symbol: 'A' Symbol: 'w' Code: 01110	Prior Symbol: 'I' Symbol: ':' Code: 101110	Prior Symbol: 'R' Symbol: 'e' Code: 11
Prior Symbol: 'B' Symbol: '27' Code: 00010	Prior Symbol: 'I' Symbol: '!' Code: 1100	Prior Symbol: 'R' Symbol: 'h' Code: 10000
Prior Symbol: 'B' Symbol: 'A' Code: 000110	Prior Symbol: 'I' Symbol: 'T' Code: 101111	Prior Symbol: 'R' Symbol: 'i' Code: 00
Prior Symbol: 'B' Symbol: 'C' Code: 0000	Prior Symbol: 'I' Symbol: 'c' Code: 10110	Prior Symbol: 'R' Symbol: 'o' Code: 01
Prior Symbol: 'B' Symbol: 'S' Code: 000111	Prior Symbol: 'I' Symbol: 'a' Code: 1010	Prior Symbol: 'R' Symbol: 'u' Code: 1001
Prior Symbol: 'B' Symbol: 'a' Code: 111	Prior Symbol: 'I' Symbol: 'n' Code: 0	Prior Symbol: 'S' Symbol: '27' Code: 101110
Prior Symbol: 'B' Symbol: 'e' Code: 01	Prior Symbol: 'I' Symbol: 'r' Code: 111111	Prior Symbol: 'S' Symbol: ':' Code: 1110100
Prior Symbol: 'B' Symbol: 'i' Code: 1010	Prior Symbol: 'I' Symbol: '' Code: 1101	Prior Symbol: 'S' Symbol: '' Code: 1011000
Prior Symbol: 'B' Symbol: 'l' Code: 1011	Prior Symbol: 'I' Symbol: 't' Code: 1110	Prior Symbol: 'S' Symbol: ':' Code: 1011011
Prior Symbol: 'B' Symbol: 'o' Code: 110	Prior Symbol: 'J' Symbol: '27' Code: 000	Prior Symbol: 'S' Symbol: 'a' Code: 1111
Prior Symbol: 'B' Symbol: 'u' Code: 001	Prior Symbol: 'J' Symbol: 'a' Code: 01	Prior Symbol: 'S' Symbol: 'c' Code: 11100
Prior Symbol: 'B' Symbol: 'u' Code: 100	Prior Symbol: 'J' Symbol: 'e' Code: 11	Prior Symbol: 'S' Symbol: 'e' Code: 000
Prior Symbol: 'C' Symbol: '27' Code: 00101	Prior Symbol: 'J' Symbol: 'o' Code: 10	Prior Symbol: 'S' Symbol: 'h' Code: 100
Prior Symbol: 'C' Symbol: '' Code: 10110	Prior Symbol: 'J' Symbol: 'u' Code: 001	Prior Symbol: 'S' Symbol: 'i' Code: 1100
Prior Symbol: 'C' Symbol: 'A' Code: 0011100	Prior Symbol: 'K' Symbol: '27' Code: 000	Prior Symbol: 'S' Symbol: 'k' Code: 101111
Prior Symbol: 'C' Symbol: 'B' Code: 0011111	Prior Symbol: 'K' Symbol: 'a' Code: 0100	Prior Symbol: 'S' Symbol: 'l' Code: 1011001
Prior Symbol: 'C' Symbol: 'O' Code: 101110	Prior Symbol: 'K' Symbol: 'e' Code: 001	Prior Symbol: 'S' Symbol: 'm' Code: 111011010
Prior Symbol: 'C' Symbol: 'a' Code: 100	Prior Symbol: 'K' Symbol: 'i' Code: 1	Prior Symbol: 'S' Symbol: 'n' Code: 1110111
Prior Symbol: 'C' Symbol: 'e' Code: 101111	Prior Symbol: 'K' Symbol: 'n' Code: 0111	Prior Symbol: 'S' Symbol: 'o' Code: 1010
Prior Symbol: 'C' Symbol: 'h' Code: 01	Prior Symbol: 'K' Symbol: 'o' Code: 0101	Prior Symbol: 'S' Symbol: 'o' Code: 001
Prior Symbol: 'C' Symbol: 'i' Code: 00110	Prior Symbol: 'K' Symbol: 'u' Code: 0110	Prior Symbol: 'S' Symbol: 'q' Code: 1011010
Prior Symbol: 'C' Symbol: 'l' Code: 000	Prior Symbol: 'L' Symbol: '27' Code: 01001	Prior Symbol: 'S' Symbol: 'r' Code: 01
Prior Symbol: 'C' Symbol: 'o' Code: 11	Prior Symbol: 'L' Symbol: 'a' Code: 01000	Prior Symbol: 'S' Symbol: 'S' Code: 1101
Prior Symbol: 'C' Symbol: 'r' Code: 1010	Prior Symbol: 'L' Symbol: 'a' Code: 10	Prior Symbol: 'S' Symbol: 'w' Code: 1110101
Prior Symbol: 'C' Symbol: 'u' Code: 00100	Prior Symbol: 'L' Symbol: 'e' Code: 011	Prior Symbol: 'T' Symbol: '27' Code: 1111010
Prior Symbol: 'C' Symbol: 'y' Code: 0011101	Prior Symbol: 'L' Symbol: 'i' Code: 11	Prior Symbol: 'T' Symbol: ':' Code: 11110110
Prior Symbol: 'D' Symbol: '27' Code: 01001	Prior Symbol: 'L' Symbol: 'o' Code: 00	Prior Symbol: 'T' Symbol: 'N' Code: 11110111
Prior Symbol: 'D' Symbol: 'a' Code: 10	Prior Symbol: 'L' Symbol: 'u' Code: 0101	Prior Symbol: 'T' Symbol: 'V' Code: 111100
Prior Symbol: 'D' Symbol: 'e' Code: 111	Prior Symbol: 'M' Symbol: '27' Code: 1011111	Prior Symbol: 'T' Symbol: 'a' Code: 1010
Prior Symbol: 'D' Symbol: 'i' Code: 110	Prior Symbol: 'M' Symbol: '' Code: 10111100	Prior Symbol: 'T' Symbol: 'o' Code: 1011
Prior Symbol: 'D' Symbol: 'o' Code: 00	Prior Symbol: 'M' Symbol: 'T' Code: 10111101	Prior Symbol: 'T' Symbol: 'h' Code: 0
Prior Symbol: 'D' Symbol: 'r' Code: 011	Prior Symbol: 'M' Symbol: 'a' Code: 11	Prior Symbol: 'T' Symbol: 'i' Code: 1110
Prior Symbol: 'D' Symbol: 'u' Code: 0101	Prior Symbol: 'M' Symbol: 'b' Code: 1011110	Prior Symbol: 'T' Symbol: 'o' Code: 110
Prior Symbol: 'D' Symbol: 'y' Code: 01000	Prior Symbol: 'M' Symbol: 'e' Code: 1010	Prior Symbol: 'T' Symbol: 'r' Code: 100
Prior Symbol: 'E' Symbol: '27' Code: 011	Prior Symbol: 'M' Symbol: 'i' Code: 100	Prior Symbol: 'T' Symbol: 'u' Code: 111110
Prior Symbol: 'E' Symbol: 'C' Code: 1010	Prior Symbol: 'M' Symbol: 'o' Code: 00	Prior Symbol: 'T' Symbol: 'u' Code: 111111
Prior Symbol: 'E' Symbol: 'a' Code: 111	Prior Symbol: 'M' Symbol: 'r' Code: 10110	Prior Symbol: 'U' Symbol: '27' Code: 101
Prior Symbol: 'E' Symbol: 'd' Code: 000	Prior Symbol: 'M' Symbol: 'u' Code: 010	Prior Symbol: 'U' Symbol: ':' Code: 1001
Prior Symbol: 'E' Symbol: 'h' Code: 1100	Prior Symbol: 'M' Symbol: 'y' Code: 011	Prior Symbol: 'U' Symbol: '!' Code: 1000
Prior Symbol: 'E' Symbol: 'm' Code: 0100	Prior Symbol: 'N' Symbol: '27' Code: 1000	Prior Symbol: 'U' Symbol: 'n' Code: 0
Prior Symbol: 'E' Symbol: 'n' Code: 1101	Prior Symbol: 'N' Symbol: ':' Code: 110001	Prior Symbol: 'U' Symbol: 'p' Code: 11
Prior Symbol: 'E' Symbol: 'q' Code: 101110	Prior Symbol: 'N' Symbol: 'B' Code: 1001	Prior Symbol: 'V' Symbol: '0' Code: 000
Prior Symbol: 'E' Symbol: 's' Code: 10110	Prior Symbol: 'N' Symbol: 'F' Code: 110010	Prior Symbol: 'V' Symbol: '27' Code: 0011
Prior Symbol: 'E' Symbol: 'u' Code: 101111	Prior Symbol: 'N' Symbol: 'N' Code: 110000	Prior Symbol: 'V' Symbol: '' Code: 01010
Prior Symbol: 'E' Symbol: 'v' Code: 100	Prior Symbol: 'N' Symbol: 'a' Code: 1101	Prior Symbol: 'V' Symbol: 'C' Code: 01011
Prior Symbol: 'E' Symbol: 'x' Code: 001	Prior Symbol: 'N' Symbol: 'e' Code: 0	Prior Symbol: 'V' Symbol: 'a' Code: 011
Prior Symbol: 'E' Symbol: 'y' Code: 0101	Prior Symbol: 'N' Symbol: 'i' Code: 111	Prior Symbol: 'V' Symbol: 'e' Code: 0100
Prior Symbol: 'F' Symbol: '27' Code: 011111	Prior Symbol: 'N' Symbol: 'o' Code: 101	Prior Symbol: 'V' Symbol: 'i' Code: 1
Prior Symbol: 'F' Symbol: ':' Code: 011110	Prior Symbol: 'N' Symbol: 'u' Code: 110011	Prior Symbol: 'V' Symbol: 'o' Code: 0010
Prior Symbol: 'F' Symbol: 'L' Code: 01110	Prior Symbol: 'O' Symbol: '27' Code: 010	Prior Symbol: 'W' Symbol: '27' Code: 00011
Prior Symbol: 'F' Symbol: 'a' Code: 10	Prior Symbol: 'O' Symbol: ':' Code: 001	Prior Symbol: 'W' Symbol: 'F' Code: 000100
Prior Symbol: 'F' Symbol: 'e' Code: 0110	Prior Symbol: 'O' Symbol: 'd' Code: 01110	Prior Symbol: 'W' Symbol: 'W' Code: 000101
Prior Symbol: 'F' Symbol: 'i' Code: 110	Prior Symbol: 'O' Symbol: 'f' Code: 11010	Prior Symbol: 'W' Symbol: 'a' Code: 111
Prior Symbol: 'F' Symbol: 'l' Code: 000	Prior Symbol: 'O' Symbol: 'i' Code: 1100	Prior Symbol: 'W' Symbol: 'e' Code: 110
Prior Symbol: 'F' Symbol: 'o' Code: 010	Prior Symbol: 'O' Symbol: 'n' Code: 10	Prior Symbol: 'W' Symbol: 'h' Code: 001
Prior Symbol: 'F' Symbol: 'r' Code: 111	Prior Symbol: 'O' Symbol: 'p' Code: 0001	Prior Symbol: 'W' Symbol: 'i' Code: 01
Prior Symbol: 'F' Symbol: 'u' Code: 001	Prior Symbol: 'O' Symbol: 'r' Code: 0110	Prior Symbol: 'W' Symbol: 'o' Code: 10
Prior Symbol: 'G' Symbol: '27' Code: 10110	Prior Symbol: 'O' Symbol: 's' Code: 01111	Prior Symbol: 'W' Symbol: 'r' Code: 0000
Prior Symbol: 'G' Symbol: ':' Code: 101010	Prior Symbol: 'O' Symbol: 'u' Code: 111	Prior Symbol: 'X' Symbol: '27' Code: 1
Prior Symbol: 'G' Symbol: 'A' Code: 101111	Prior Symbol: 'O' Symbol: 'v' Code: 11011	Prior Symbol: 'Y' Symbol: '27' Code: 001
Prior Symbol: 'G' Symbol: 'a' Code: 1110	Prior Symbol: 'O' Symbol: 'w' Code: 0000	Prior Symbol: 'Y' Symbol: 'a' Code: 000
Prior Symbol: 'G' Symbol: 'e' Code: 110	Prior Symbol: 'P' Symbol: '27' Code: 111111	Prior Symbol: 'Y' Symbol: 'e' Code: 01
Prior Symbol: 'G' Symbol: 'h' Code: 10100	Prior Symbol: 'P' Symbol: '' Code: 1111100	Prior Symbol: 'Y' Symbol: 'o' Code: 1
Prior Symbol: 'G' Symbol: 'i' Code: 100	Prior Symbol: 'P' Symbol: ':' Code: 011001	Prior Symbol: 'Z' Symbol: '27' Code: 00
Prior Symbol: 'G' Symbol: 'l' Code: 101011	Prior Symbol: 'P' Symbol: 'G' Code: 111101	Prior Symbol: 'Z' Symbol: 'a' Code: 01
Prior Symbol: 'G' Symbol: 'o' Code: 01	Prior Symbol: 'P' Symbol: 'R' Code: 111100	Prior Symbol: 'Z' Symbol: 'o' Code: 1
Prior Symbol: 'G' Symbol: 'r' Code: 00	Prior Symbol: 'P' Symbol: 'a' Code: 00	Prior Symbol: 'Z' Symbol: 'i' Code: 1
Prior Symbol: 'G' Symbol: 'u' Code: 1111	Prior Symbol: 'P' Symbol: 'e' Code: 010	Prior Symbol: 'Z' Symbol: 'r' Code: 1
Prior Symbol: 'G' Symbol: 'y' Code: 101110	Prior Symbol: 'P' Symbol: 'i' Code: 0111	Prior Symbol: 'Z' Symbol: 't' Code: 1
Prior Symbol: 'H' Symbol: '0' Code: 111010	Prior Symbol: 'P' Symbol: 'o' Code: 1110	Prior Symbol: '[' Symbol: '27' Code: 1
Prior Symbol: 'H' Symbol: '27' Code: 111011	Prior Symbol: 'P' Symbol: 'o' Code: 110	Prior Symbol: '_' Symbol: '27' Code: 1
Prior Symbol: 'H' Symbol: 'a' Code: 110	Prior Symbol: 'P' Symbol: 'r' Code: 10	Prior Symbol: '^' Symbol: '27' Code: 1
Prior Symbol: 'H' Symbol: 'e' Code: 10	Prior Symbol: 'P' Symbol: 's' Code: 1111101	Prior Symbol: 'a' Symbol: '0' Code: 00010

Prior Symbol: 'n' Symbol: 'c' Code: 01111
 Prior Symbol: 'n' Symbol: 'd' Code: 001
 Prior Symbol: 'n' Symbol: 'e' Code: 010
 Prior Symbol: 'n' Symbol: 'f' Code: 1001011
 Prior Symbol: 'n' Symbol: 'g' Code: 101
 Prior Symbol: 'n' Symbol: 'h' Code: 111010101
 Prior Symbol: 'n' Symbol: 'i' Code: 1000
 Prior Symbol: 'n' Symbol: 'j' Code: 111010001
 Prior Symbol: 'n' Symbol: 'k' Code: 1110110
 Prior Symbol: 'n' Symbol: 'l' Code: 111010110
 Prior Symbol: 'n' Symbol: 'm' Code: 111010111
 Prior Symbol: 'n' Symbol: 'n' Code: 10011
 Prior Symbol: 'n' Symbol: 'o' Code: 1110111
 Prior Symbol: 'n' Symbol: 'r' Code: 111010100
 Prior Symbol: 'n' Symbol: 's' Code: 0110
 Prior Symbol: 'n' Symbol: 't' Code: 1111
 Prior Symbol: 'n' Symbol: 'u' Code: 111010001
 Prior Symbol: 'n' Symbol: 'v' Code: 0111000
 Prior Symbol: 'n' Symbol: 'y' Code: 100100
 Prior Symbol: 'n' Symbol: 'z' Code: 01110010
 Prior Symbol: 'o' Symbol: 0 Code: 00101
 Prior Symbol: 'o' Symbol: 27 Code: 01110001
 Prior Symbol: 'o' Symbol: '' Code: 0101
 Prior Symbol: 'o' Symbol: ' ' Code: 01110000
 Prior Symbol: 'o' Symbol: '.' Code: 0111011010
 Prior Symbol: 'o' Symbol: '?' Code: 011101100
 Prior Symbol: 'o' Symbol: 'a' Code: 1100010
 Prior Symbol: 'o' Symbol: 'b' Code: 001001
 Prior Symbol: 'o' Symbol: 'c' Code: 110000
 Prior Symbol: 'o' Symbol: 'd' Code: 01111
 Prior Symbol: 'o' Symbol: 'e' Code: 0111001
 Prior Symbol: 'o' Symbol: 'f' Code: 1001
 Prior Symbol: 'o' Symbol: 'g' Code: 00010
 Prior Symbol: 'o' Symbol: 'h' Code: 0111010
 Prior Symbol: 'o' Symbol: 'i' Code: 01110111
 Prior Symbol: 'o' Symbol: 'k' Code: 1100011
 Prior Symbol: 'o' Symbol: 'l' Code: 0100
 Prior Symbol: 'o' Symbol: 'm' Code: 1000
 Prior Symbol: 'o' Symbol: 'n' Code: 111
 Prior Symbol: 'o' Symbol: 'p' Code: 0011
 Prior Symbol: 'o' Symbol: 'r' Code: 01101
 Prior Symbol: 'o' Symbol: 't' Code: 101
 Prior Symbol: 'o' Symbol: 'v' Code: 11001
 Prior Symbol: 'o' Symbol: 'f' Code: 00011
 Prior Symbol: 'o' Symbol: 'u' Code: 1101
 Prior Symbol: 'o' Symbol: 'v' Code: 01100
 Prior Symbol: 'o' Symbol: 'w' Code: 0000
 Prior Symbol: 'o' Symbol: 'x' Code: 0010000
 Prior Symbol: 'o' Symbol: 'y' Code: 0010001
 Prior Symbol: 'o' Symbol: 'z' Code: 0111011011
 Prior Symbol: 'p' Symbol: 0 Code: 1101
 Prior Symbol: 'p' Symbol: 27 Code: 101110
 Prior Symbol: 'p' Symbol: '' Code: 010
 Prior Symbol: 'p' Symbol: ' ' Code: 1100101
 Prior Symbol: 'p' Symbol: 'a' Code: 1001
 Prior Symbol: 'p' Symbol: 'd' Code: 101111
 Prior Symbol: 'p' Symbol: 'e' Code: 111
 Prior Symbol: 'p' Symbol: 'h' Code: 11000
 Prior Symbol: 'p' Symbol: 'i' Code: 1010
 Prior Symbol: 'p' Symbol: 'l' Code: 0110
 Prior Symbol: 'p' Symbol: 'm' Code: 1100100
 Prior Symbol: 'p' Symbol: 'o' Code: 00
 Prior Symbol: 'p' Symbol: 'p' Code: 0111
 Prior Symbol: 'p' Symbol: 'r' Code: 10001
 Prior Symbol: 'p' Symbol: 's' Code: 10000
 Prior Symbol: 'p' Symbol: 't' Code: 10110
 Prior Symbol: 'p' Symbol: 'y' Code: 110011
 Prior Symbol: 'q' Symbol: 27 Code: 0
 Prior Symbol: 'q' Symbol: 'u' Code: 1
 Prior Symbol: 'r' Symbol: 0 Code: 1001
 Prior Symbol: 'r' Symbol: 27 Code: 01100101
 Prior Symbol: 'r' Symbol: '' Code: 1111
 Prior Symbol: 'r' Symbol: ' ' Code: 0110011
 Prior Symbol: 'r' Symbol: '.' Code: 110011101
 Prior Symbol: 'r' Symbol: ':' Code: 0111100
 Prior Symbol: 'r' Symbol: ';' Code: 110011100
 Prior Symbol: 'r' Symbol: 'a' Code: 000

Prior Symbol: 'r' Symbol: 'b' Code: 01111101
 Prior Symbol: 'r' Symbol: 'c' Code: 0111111
 Prior Symbol: 'r' Symbol: 'd' Code: 11000
 Prior Symbol: 'r' Symbol: 'e' Code: 101
 Prior Symbol: 'r' Symbol: 'f' Code: 11001111
 Prior Symbol: 'r' Symbol: 'g' Code: 0111101
 Prior Symbol: 'r' Symbol: 'i' Code: 010
 Prior Symbol: 'r' Symbol: 'k' Code: 110010
 Prior Symbol: 'r' Symbol: 'l' Code: 0011
 Prior Symbol: 'r' Symbol: 'm' Code: 011000
 Prior Symbol: 'r' Symbol: 'n' Code: 01101
 Prior Symbol: 'r' Symbol: 't' Code: 1101
 Prior Symbol: 'r' Symbol: 'p' Code: 01111100
 Prior Symbol: 'r' Symbol: 'r' Code: 01110
 Prior Symbol: 'r' Symbol: 's' Code: 1110
 Prior Symbol: 'r' Symbol: 't' Code: 1000
 Prior Symbol: 'r' Symbol: 'u' Code: 1100110
 Prior Symbol: 'r' Symbol: 'v' Code: 01100100
 Prior Symbol: 'r' Symbol: 'y' Code: 0010
 Prior Symbol: 's' Symbol: 0 Code: 11
 Prior Symbol: 's' Symbol: 27 Code: 0010011
 Prior Symbol: 's' Symbol: '' Code: 01
 Prior Symbol: 's' Symbol: ' ' Code: 001011010
 Prior Symbol: 's' Symbol: '.' Code: 001011011
 Prior Symbol: 's' Symbol: ':' Code: 00100101
 Prior Symbol: 's' Symbol: ':' Code: 0000001
 Prior Symbol: 's' Symbol: '?' Code: 001011100
 Prior Symbol: 's' Symbol: 'C' Code: 001011101
 Prior Symbol: 's' Symbol: 'H' Code: 001011110
 Prior Symbol: 's' Symbol: 'a' Code: 101010
 Prior Symbol: 's' Symbol: 'c' Code: 101011
 Prior Symbol: 's' Symbol: 'd' Code: 001011111
 Prior Symbol: 's' Symbol: 'e' Code: 1011
 Prior Symbol: 's' Symbol: 'f' Code: 00000000
 Prior Symbol: 's' Symbol: 'h' Code: 00001
 Prior Symbol: 's' Symbol: 'i' Code: 0011
 Prior Symbol: 's' Symbol: 'k' Code: 000001
 Prior Symbol: 's' Symbol: 'l' Code: 00101010
 Prior Symbol: 's' Symbol: 'm' Code: 00000001
 Prior Symbol: 's' Symbol: 'n' Code: 00101011
 Prior Symbol: 's' Symbol: 'o' Code: 10100
 Prior Symbol: 's' Symbol: 'p' Code: 001000
 Prior Symbol: 's' Symbol: 'r' Code: 00100100
 Prior Symbol: 's' Symbol: 's' Code: 0001
 Prior Symbol: 's' Symbol: 't' Code: 100
 Prior Symbol: 's' Symbol: 'u' Code: 0010100
 Prior Symbol: 's' Symbol: 'y' Code: 00101100
 Prior Symbol: 't' Symbol: 0 Code: 010
 Prior Symbol: 't' Symbol: 27 Code: 11000010
 Prior Symbol: 't' Symbol: '' Code: 101
 Prior Symbol: 't' Symbol: ' ' Code: 11000011
 Prior Symbol: 't' Symbol: '.' Code: 110110000
 Prior Symbol: 't' Symbol: '?' Code: 110110001
 Prior Symbol: 't' Symbol: 'a' Code: 0000
 Prior Symbol: 't' Symbol: 'b' Code: 100000
 Prior Symbol: 't' Symbol: 'c' Code: 1101101
 Prior Symbol: 't' Symbol: 'd' Code: 11000000
 Prior Symbol: 't' Symbol: 'e' Code: 011
 Prior Symbol: 't' Symbol: 'h' Code: 111
 Prior Symbol: 't' Symbol: 'i' Code: 001
 Prior Symbol: 't' Symbol: 'l' Code: 10001
 Prior Symbol: 't' Symbol: 'm' Code: 100001
 Prior Symbol: 't' Symbol: 'n' Code: 11011001
 Prior Symbol: 't' Symbol: 'o' Code: 1001
 Prior Symbol: 't' Symbol: 'r' Code: 11010
 Prior Symbol: 't' Symbol: 's' Code: 0001
 Prior Symbol: 't' Symbol: 't' Code: 110111
 Prior Symbol: 't' Symbol: 'u' Code: 11001
 Prior Symbol: 't' Symbol: 'w' Code: 11000001
 Prior Symbol: 't' Symbol: 'y' Code: 110001
 Prior Symbol: 'u' Symbol: 0 Code: 0011110
 Prior Symbol: 'u' Symbol: 27 Code: 000100
 Prior Symbol: 'u' Symbol: '' Code: 001110
 Prior Symbol: 'u' Symbol: ' ' Code: 00110
 Prior Symbol: 'u' Symbol: 'a' Code: 00110
 Prior Symbol: 'u' Symbol: 'b' Code: 10011
 Prior Symbol: 'u' Symbol: 'c' Code: 11100
 Prior Symbol: 'u' Symbol: 'd' Code: 10000

Prior Symbol: 'u' Symbol: 'e' Code: 0010
 Prior Symbol: 'u' Symbol: 'f' Code: 0011111
 Prior Symbol: 'u' Symbol: 'g' Code: 11101
 Prior Symbol: 'u' Symbol: 'i' Code: 00011
 Prior Symbol: 'u' Symbol: 'k' Code: 0001010
 Prior Symbol: 'u' Symbol: 'l' Code: 0000
 Prior Symbol: 'u' Symbol: 'm' Code: 10010
 Prior Symbol: 'u' Symbol: 'n' Code: 110
 Prior Symbol: 'u' Symbol: 'p' Code: 10001
 Prior Symbol: 'u' Symbol: 'r' Code: 01
 Prior Symbol: 'u' Symbol: 's' Code: 101
 Prior Symbol: 'u' Symbol: 't' Code: 1111
 Prior Symbol: 'u' Symbol: 'z' Code: 0001011
 Prior Symbol: 'v' Symbol: 27 Code: 0010
 Prior Symbol: 'v' Symbol: 'l' Code: 000
 Prior Symbol: 'v' Symbol: 'e' Code: 1
 Prior Symbol: 'v' Symbol: 'f' Code: 01
 Prior Symbol: 'v' Symbol: 'p' Code: 00111
 Prior Symbol: 'v' Symbol: 's' Code: 00110
 Prior Symbol: 'w' Symbol: 0 Code: 001
 Prior Symbol: 'w' Symbol: 27 Code: 01010
 Prior Symbol: 'w' Symbol: '' Code: 011
 Prior Symbol: 'w' Symbol: ' ' Code: 010010
 Prior Symbol: 'w' Symbol: 'a' Code: 000
 Prior Symbol: 'w' Symbol: 'b' Code: 010011
 Prior Symbol: 'w' Symbol: 'c' Code: 010111
 Prior Symbol: 'w' Symbol: 'e' Code: 1111
 Prior Symbol: 'w' Symbol: 'f' Code: 1100
 Prior Symbol: 'w' Symbol: 'l' Code: 011010
 Prior Symbol: 'w' Symbol: 'n' Code: 1110
 Prior Symbol: 'w' Symbol: 'o' Code: 1101
 Prior Symbol: 'w' Symbol: 'r' Code: 01000
 Prior Symbol: 'w' Symbol: 's' Code: 10
 Prior Symbol: 'x' Symbol: 0 Code: 110
 Prior Symbol: 'x' Symbol: 27 Code: 1010
 Prior Symbol: 'x' Symbol: '' Code: 1011
 Prior Symbol: 'x' Symbol: 'a' Code: 000
 Prior Symbol: 'x' Symbol: 'e' Code: 001
 Prior Symbol: 'x' Symbol: 'f' Code: 100
 Prior Symbol: 'x' Symbol: 'g' Code: 111
 Prior Symbol: 'x' Symbol: 'l' Code: 01
 Prior Symbol: 'y' Symbol: 0 Code: 10
 Prior Symbol: 'y' Symbol: 27 Code: 111110
 Prior Symbol: 'y' Symbol: '' Code: 0
 Prior Symbol: 'y' Symbol: '!' Code: 1101101
 Prior Symbol: 'y' Symbol: ' ' Code: 110101
 Prior Symbol: 'y' Symbol: ':' Code: 11110101
 Prior Symbol: 'y' Symbol: 'a' Code: 1101110
 Prior Symbol: 'y' Symbol: 'b' Code: 1111011
 Prior Symbol: 'y' Symbol: 'c' Code: 11110100
 Prior Symbol: 'y' Symbol: 'd' Code: 1100000
 Prior Symbol: 'y' Symbol: 'm' Code: 1101111
 Prior Symbol: 'y' Symbol: 'f' Code: 1100001
 Prior Symbol: 'y' Symbol: 'l' Code: 111111
 Prior Symbol: 'y' Symbol: 'm' Code: 1101111
 Prior Symbol: 'y' Symbol: 'h' Code: 1100010
 Prior Symbol: 'y' Symbol: 'o' Code: 1100011
 Prior Symbol: 'y' Symbol: 'p' Code: 1101000
 Prior Symbol: 'y' Symbol: 's' Code: 1110
 Prior Symbol: 'y' Symbol: 't' Code: 1101001
 Prior Symbol: 'y' Symbol: 'w' Code: 1101100
 Prior Symbol: 'z' Symbol: 0 Code: 110
 Prior Symbol: 'z' Symbol: 27 Code: 100
 Prior Symbol: 'z' Symbol: '' Code: 000
 Prior Symbol: 'z' Symbol: 'a' Code: 01
 Prior Symbol: 'z' Symbol: 'e' Code: 1010
 Prior Symbol: 'z' Symbol: 'f' Code: 111
 Prior Symbol: 'z' Symbol: 'g' Code: 001
 Prior Symbol: 'z' Symbol: 'y' Code: 1011
 Prior Symbol: 'f' Symbol: 27 Code: 1
 Prior Symbol: 'l' Symbol: 27 Code: 1
 Prior Symbol: 'j' Symbol: 27 Code: 1
 Prior Symbol: '-' Symbol: 27 Code: 1
 Prior Symbol: 127 Symbol: 27 Code: 1

Table C5 English-language Program Title Decode Table

0 1	76 1	152 3	228 6	304 212	380 185	456 35
1 0	77 218	153 50	229 102	305 18	381 1	457 36
2 1	78 1	154 3	230 6	306 19	382 167	458 37
3 58	79 220	155 62	231 154	307 20	383 177	459 38
4 1	80 1	156 3	232 6	308 21	384 236	460 39
5 60	81 230	157 82	233 208	309 22	385 209	461 40
6 1	82 1	158 3	234 6	310 23	386 2	462 1
7 62	83 232	159 100	235 252	311 24	387 173	463 128
8 1	84 1	160 3	236 7	312 25	388 178	464 160
9 64	85 234	161 122	237 34	313 26	389 218	465 155
10 1	86 1	162 3	238 7	314 155	390 227	466 155
11 66	87 240	163 148	239 44	315 155	391 179	467 155
12 1	88 1	164 3	240 7	316 155	392 3	468 155
13 68	89 242	165 152	241 70	317 155	393 228	469 155
14 1	90 1	166 3	242 7	318 155	394 230	470 177
15 70	91 244	167 164	243 84	319 155	395 4	471 155
16 1	92 2	168 3	244 7	320 155	396 155	472 155
17 72	93 6	169 200	245 124	321 155	397 226	473 155
18 1	94 2	170 3	246 7	322 155	398 5	474 155
19 74	95 18	171 222	247 138	323 155	399 6	475 160
20 1	96 2	172 3	248 7	324 155	400 7	476 4
21 76	97 20	173 230	249 140	325 155	401 8	477 243
22 1	98 2	174 3	250 7	326 155	402 9	478 228
23 78	99 28	175 244	251 142	327 155	403 213	479 185
24 1	100 2	176 4	252 7	328 155	404 10	480 1
25 80	101 40	177 4	253 144	329 155	405 214	481 244
26 1	102 2	178 4	254 7	330 155	406 11	482 160
27 82	103 48	179 6	255 146	331 155	407 217	483 155
28 1	104 2	180 4	256 27	332 155	408 12	484 2
29 84	105 52	181 12	257 28	333 155	409 166	485 3
30 1	106 2	182 4	258 180	334 155	410 233	486 155
31 86	107 54	183 16	259 164	335 155	411 203	487 155
32 1	108 2	184 4	260 178	336 155	412 197	488 155
33 88	109 56	185 18	261 183	337 155	413 207	489 155
34 1	110 2	186 4	262 218	338 155	414 13	490 1
35 90	111 58	187 20	263 1	339 155	415 14	491 2
36 1	112 2	188 4	264 209	340 155	416 202	492 155
37 92	113 60	189 22	265 2	341 155	417 201	493 193
38 1	114 2	190 4	266 3	342 155	418 15	494 200
39 94	115 62	191 24	267 155	343 155	419 199	495 211
40 1	116 2	192 4	268 4	344 155	420 16	496 155
41 96	117 70	193 26	269 213	345 155	421 17	497 155
42 1	118 2	194 4	270 217	346 155	422 225	498 155
43 98	119 72	195 28	271 5	347 155	423 18	499 160
44 1	120 2	196 4	272 203	348 155	424 19	500 7
45 100	121 74	197 82	273 214	349 155	425 198	501 8
46 1	122 2	198 4	274 6	350 155	426 210	502 177
47 102	123 76	199 106	275 207	351 155	427 200	503 210
48 1	124 2	200 4	276 7	352 155	428 206	504 211
49 104	125 78	201 142	277 8	353 155	429 193	505 212
50 1	126 2	202 4	278 202	354 155	430 196	506 213
51 106	127 80	203 174	279 9	355 155	431 208	507 173
52 1	128 2	204 4	280 201	356 155	432 204	508 205
53 108	129 82	205 238	281 197	357 155	433 20	509 193
54 1	130 2	206 5	282 198	358 155	434 21	510 1
55 110	131 84	207 6	283 10	359 155	435 239	511 2
56 1	132 2	208 5	284 210	360 155	436 194	512 3
57 112	133 126	209 40	285 196	361 155	437 215	513 160
58 1	134 2	210 5	286 199	362 155	438 22	514 4
59 114	135 146	211 68	287 204	363 155	439 205	515 155
60 1	136 2	212 5	288 208	364 155	440 23	516 5
61 116	137 172	213 114	289 200	365 155	441 244	517 6
62 1	138 2	214 5	290 215	366 155	442 212	518 160
63 118	139 186	215 118	291 206	367 155	443 24	519 5
64 1	140 2	216 5	292 11	368 155	444 25	520 201
65 120	141 210	217 144	293 193	369 155	445 26	521 215
66 1	142 2	218 5	294 12	370 155	446 195	522 211
67 206	143 228	219 190	295 194	371 155	447 211	523 1
68 1	144 2	220 5	296 205	372 155	448 27	524 2
69 210	145 250	221 214	297 195	373 155	449 28	525 155
70 1	146 3	222 6	298 13	374 155	450 29	526 174
71 212	147 6	223 10	299 14	375 155	451 30	527 128
72 1	148 3	224 6	300 15	376 41	452 31	528 3
73 214	149 30	225 68	301 16	377 42	453 32	529 4
74 1	150 3	226 6	302 211	378 216	454 33	530 155
75 216	151 38	227 100	303 17	379 229	455 34	531 155

532 2	612 227	692 233	772 229	852 206	932 16	1012 6
533 3	613 230	693 229	773 4	853 160	933 17	1013 7
534 173	614 247	694 239	774 238	854 198	934 170	1014 198
535 155	615 3	695 3	775 11	855 245	935 236	1015 215
536 1	616 245	696 225	776 186	856 1	936 241	1016 1
537 128	617 4	697 4	777 212	857 2	937 174	1017 155
538 160	618 5	698 10	778 174	858 155	938 160	1018 242
539 176	619 6	699 11	779 242	859 194	939 247	1019 2
540 4	620 242	700 241	780 227	860 3	940 237	1020 3
541 5	621 7	701 245	781 1	861 225	941 238	1021 232
542 128	622 8	702 243	782 160	862 4	942 1	1022 229
543 155	623 9	703 1	783 2	863 239	943 2	1023 225
544 177	624 10	704 237	784 128	864 5	944 155	1024 4
545 178	625 11	705 249	785 155	865 233	945 235	1025 233
546 160	626 12	706 195	786 237	866 6	946 3	1026 239
547 176	627 228	707 2	787 3	867 7	947 4	1027 5
548 185	628 160	708 236	788 201	868 9	948 5	1028 155
549 1	629 13	709 238	789 243	869 10	949 6	1029 155
550 2	630 236	710 228	790 244	870 228	950 227	1030 2
551 3	631 238	711 248	791 4	871 243	951 7	1031 239
552 2	632 14	712 3	792 5	872 230	952 239	1032 225
553 3	633 237	713 155	793 6	873 246	953 8	1033 155
554 177	634 15	714 246	794 7	874 247	954 233	1034 1
555 186	635 16	715 4	795 8	875 240	955 245	1035 229
556 1	636 17	716 5	796 9	876 242	956 9	1036 1
557 176	637 18	717 225	797 10	877 1	957 225	1037 239
558 155	638 8	718 6	798 2	878 236	958 229	1038 155
559 128	639 9	719 7	799 3	879 2	959 240	1039 225
560 128	640 193	720 8	800 155	880 3	960 232	1040 155
561 1	641 211	721 9	801 245	881 160	961 10	1041 155
562 176	642 155	722 7	802 1	882 155	962 11	1042 155
563 155	643 1	723 8	803 225	883 4	963 12	1043 155
564 155	644 195	724 160	804 239	884 5	964 13	1044 155
565 184	645 2	725 155	805 229	885 245	965 244	1045 155
566 155	646 233	726 204	806 5	886 6	966 14	1046 155
567 155	647 236	727 1	807 233	887 7	967 15	1047 155
568 155	648 3	728 229	808 225	888 238	968 232	1048 155
569 155	649 242	729 2	809 239	889 8	969 10	1049 155
570 155	650 245	730 236	810 245	890 11	970 173	1050 155
571 176	651 4	731 245	811 238	891 12	971 206	1051 155
572 155	652 239	732 239	812 155	892 160	972 155	1052 25
573 160	653 225	733 3	813 229	893 243	973 1	1053 26
574 2	654 5	734 233	814 1	894 249	974 214	1054 155
575 3	655 229	735 242	815 2	895 174	975 2	1055 186
576 177	656 6	736 4	816 3	896 210	976 245	1056 229
577 179	657 7	737 5	817 4	897 199	977 247	1057 234
578 185	658 11	738 225	818 4	898 1	978 3	1058 248
579 176	659 12	739 6	819 5	899 155	979 4	1059 1
580 1	660 193	740 9	820 160	900 2	980 225	1060 2
581 155	661 249	741 10	821 155	901 245	981 229	1061 230
582 155	662 1	742 174	822 1	902 3	982 233	1062 167
583 160	663 194	743 236	823 245	903 4	983 5	1063 3
584 155	664 207	744 249	824 2	904 5	984 242	1064 250
585 155	665 229	745 193	825 229	905 233	985 6	1065 232
586 155	666 245	746 232	826 239	906 236	986 239	1066 4
587 155	667 155	747 1	827 3	907 6	987 7	1067 247
588 155	668 233	748 155	828 225	908 229	988 8	1068 5
589 155	669 2	749 2	829 233	909 7	989 9	1069 245
590 155	670 160	750 3	830 8	910 239	990 238	1070 226
591 155	671 3	751 4	831 9	911 8	991 3	1071 6
592 155	672 4	752 225	832 170	912 225	992 236	1072 235
593 128	673 5	753 245	833 212	913 9	993 174	1073 7
594 155	674 242	754 233	834 1	914 242	994 1	1074 240
595 155	675 6	755 5	835 155	915 10	995 155	1075 8
596 19	676 236	756 229	836 227	916 1	996 2	1076 128
597 20	677 7	757 6	837 2	917 245	997 240	1077 246
598 170	678 225	758 242	838 242	918 155	998 6	1078 231
599 173	679 8	759 239	839 3	919 214	999 233	1079 9
600 174	680 9	760 7	840 229	920 4	1000 160	1080 228
601 246	681 232	761 8	841 4	921 5	1001 195	1081 10
602 231	682 10	762 239	842 245	922 232	1002 239	1082 160
603 244	683 239	763 5	843 249	923 155	1003 155	1083 233
604 226	684 5	764 128	844 233	924 1	1004 229	1084 11
605 233	685 6	765 155	845 5	925 245	1005 1	1085 227
606 1	686 249	766 245	846 239	926 2	1006 128	1086 249
607 2	687 155	767 1	847 6	927 225	1007 2	1087 12
608 194	688 1	768 2	848 7	928 233	1008 3	1088 13
609 240	689 245	769 233	849 225	929 239	1009 225	1089 237
610 155	690 2	770 225	850 229	930 3	1010 4	1090 14
611 243	691 242	771 3	851 8	931 229	1011 5	1091 15

1092 243	1172 236	1252 23	1332 4	1412 4	1492 9	1572 9
1093 16	1173 2	1253 128	1333 242	1413 5	1493 229	1573 128
1094 17	1174 228	1254 24	1334 5	1414 243	1494 24	1574 246
1095 236	1175 231	1255 25	1335 128	1415 6	1495 25	1575 240
1096 18	1176 242	1256 242	1336 6	1416 7	1496 226	1576 10
1097 244	1177 3	1257 26	1337 160	1417 8	1497 234	1577 228
1098 242	1178 155	1258 27	1338 225	1418 233	1498 242	1578 11
1099 19	1179 239	1259 160	1339 239	1419 160	1499 232	1579 243
1100 238	1180 4	1260 28	1340 7	1420 9	1500 236	1580 247
1101 20	1181 246	1261 29	1341 244	1421 128	1501 237	1581 12
1102 21	1182 5	1262 160	1342 233	1422 229	1502 250	1582 13
1103 22	1183 6	1263 11	1343 8	1423 10	1503 155	1583 239
1104 23	1184 249	1264 245	1344 9	1424 21	1504 1	1584 236
1105 24	1185 243	1265 155	1345 10	1425 22	1505 245	1585 160
1106 10	1186 7	1266 1	1346 11	1426 167	1506 2	1586 14
1107 11	1187 233	1267 236	1347 12	1427 186	1507 3	1587 15
1108 243	1188 225	1268 243	1348 21	1428 227	1508 246	1588 237
1109 155	1189 8	1269 242	1349 22	1429 247	1509 4	1589 230
1110 245	1190 9	1270 128	1350 161	1430 242	1510 186	1590 16
1111 226	1191 128	1271 225	1351 248	1431 173	1511 230	1591 245
1112 1	1192 10	1272 2	1352 233	1432 226	1512 5	1592 17
1113 128	1193 11	1273 3	1353 235	1433 1	1513 6	1593 18
1114 160	1194 229	1274 244	1354 1	1434 2	1514 235	1594 19
1115 2	1195 12	1275 233	1355 128	1435 155	1515 239	1595 20
1116 229	1196 13	1276 239	1356 155	1436 230	1516 7	1596 21
1117 242	1197 160	1277 230	1357 250	1437 3	1517 167	1597 242
1118 233	1198 30	1278 4	1358 226	1438 237	1518 249	1598 22
1119 3	1199 31	1279 5	1359 2	1439 246	1519 8	1599 238
1120 236	1200 155	1280 6	1360 3	1440 4	1520 9	1600 23
1121 4	1201 161	1281 7	1361 4	1441 235	1521 10	1601 24
1122 249	1202 173	1282 229	1362 160	1442 5	1522 11	1602 25
1123 5	1203 232	1283 8	1363 240	1443 244	1523 227	1603 26
1124 239	1204 234	1284 9	1364 5	1444 6	1524 12	1604 14
1125 6	1205 241	1285 10	1365 6	1445 7	1525 238	1605 15
1126 225	1206 245	1286 15	1366 7	1446 8	1526 225	1606 237
1127 7	1207 250	1287 16	1367 225	1447 243	1527 13	1607 167
1128 8	1208 1	1288 186	1368 8	1448 9	1528 243	1608 155
1129 9	1209 2	1289 249	1369 230	1449 245	1529 14	1609 228
1130 16	1210 3	1290 167	1370 242	1450 10	1530 233	1610 1
1131 17	1211 4	1291 244	1371 237	1451 239	1531 15	1611 249
1132 195	1212 186	1292 155	1372 246	1452 11	1532 16	1612 243
1133 204	1213 248	1293 1	1373 9	1453 12	1533 244	1613 242
1134 199	1214 167	1294 231	1374 228	1454 128	1534 128	1614 244
1135 155	1215 226	1295 236	1375 10	1455 249	1535 228	1615 2
1136 227	1216 233	1296 2	1376 239	1456 225	1536 229	1616 232
1137 1	1217 5	1297 238	1377 244	1457 13	1537 17	1617 3
1138 128	1218 6	1298 3	1378 236	1458 228	1538 18	1618 236
1139 236	1219 7	1299 239	1379 243	1459 233	1539 231	1619 240
1140 249	1220 230	1300 245	1380 231	1460 160	1540 160	1620 4
1141 2	1221 237	1301 4	1381 229	1461 14	1541 19	1621 225
1142 243	1222 231	1302 242	1382 11	1462 15	1542 20	1622 233
1143 3	1223 235	1303 5	1383 227	1463 236	1543 21	1623 5
1144 245	1224 8	1304 6	1384 12	1464 229	1544 22	1624 6
1145 4	1225 9	1305 233	1385 13	1465 16	1545 23	1625 128
1146 5	1226 246	1306 7	1386 14	1466 17	1546 27	1626 160
1147 242	1227 240	1307 243	1387 15	1467 18	1547 28	1627 7
1148 6	1228 10	1308 225	1388 16	1468 19	1548 174	1628 8
1149 233	1229 239	1309 8	1389 17	1469 20	1549 250	1629 9
1150 160	1230 11	1310 9	1390 18	1470 10	1550 191	1630 10
1151 7	1231 227	1311 10	1391 19	1471 11	1551 1	1631 229
1152 8	1232 12	1312 11	1392 238	1472 249	1552 167	1632 239
1153 239	1233 13	1313 229	1393 20	1473 155	1553 155	1633 11
1154 244	1234 14	1314 128	1394 239	1474 245	1554 2	1634 12
1155 9	1235 249	1315 12	1395 1	1475 243	1555 233	1635 13
1156 10	1236 15	1316 232	1396 155	1476 1	1556 248	1636 155
1157 225	1237 228	1317 160	1397 225	1477 2	1557 249	1637 245
1158 11	1238 236	1318 13	1398 11	1478 226	1558 3	1638 24
1159 232	1239 16	1319 14	1399 12	1479 237	1559 229	1639 25
1160 235	1240 229	1320 229	1400 212	1480 128	1560 232	1640 186
1161 229	1241 17	1321 13	1401 239	1481 3	1561 4	1641 172
1162 12	1242 244	1322 226	1402 230	1482 240	1562 225	1642 246
1163 13	1243 247	1323 245	1403 236	1483 239	1563 235	1643 155
1164 14	1244 18	1324 247	1404 247	1484 4	1564 5	1644 240
1165 15	1245 19	1325 155	1405 225	1485 160	1565 226	1645 226
1166 14	1246 225	1326 236	1406 1	1486 5	1566 6	1646 1
1167 15	1247 20	1327 1	1407 186	1487 233	1567 7	1647 230
1168 174	1248 21	1328 249	1408 2	1488 6	1568 227	1648 2
1169 245	1249 22	1329 238	1409 155	1489 225	1569 8	1649 167
1170 247	1250 238	1330 2	1410 249	1490 7	1570 231	1650 174
1171 1	1251 243	1331 3	1411 3	1491 8	1571 244	1651 231

1652 3	1694 191	1736 20	1778 128	1820 238	1862 5	1904 9
1653 227	1695 195	1737 21	1779 229	1821 13	1863 6	1905 10
1654 245	1696 200	1738 244	1780 14	1822 14	1864 155	1906 11
1655 4	1697 228	1739 22	1781 160	1823 242	1865 160	1907 12
1656 237	1698 230	1740 23	1782 15	1824 15	1866 225	1908 13
1657 5	1699 237	1741 160	1783 232	1825 16	1867 229	1909 14
1658 6	1700 242	1742 24	1784 16	1826 4	1868 233	1910 243
1659 7	1701 174	1743 128	1785 17	1827 229	1869 1	1911 15
1660 235	1702 236	1744 20	1786 18	1828 243	1870 128	1912 16
1661 8	1703 238	1745 21	1787 19	1829 239	1871 240	1913 17
1662 9	1704 249	1746 186	1788 17	1830 155	1872 2	1914 128
1663 238	1705 1	1747 191	1789 18	1831 1	1873 244	1915 18
1664 242	1706 2	1748 228	1790 235	1832 225	1874 3	1916 5
1665 10	1707 3	1749 247	1791 250	1833 2	1875 4	1917 6
1666 228	1708 4	1750 155	1792 128	1834 3	1876 160	1918 229
1667 11	1709 186	1751 167	1793 230	1835 233	1877 19	1919 250
1668 249	1710 5	1752 1	1794 155	1836 11	1878 227	1920 160
1669 236	1711 155	1753 238	1795 1	1837 12	1879 173	1921 249
1670 12	1712 245	1754 2	1796 160	1838 167	1880 228	1922 155
1671 13	1713 6	1755 3	1797 2	1839 226	1881 233	1923 1
1672 244	1714 7	1756 4	1798 3	1840 236	1882 238	1924 128
1673 128	1715 8	1757 227	1799 233	1841 227	1883 239	1925 233
1674 14	1716 9	1758 226	1800 225	1842 242	1884 240	1926 2
1675 239	1717 235	1759 237	1801 4	1843 1	1885 244	1927 225
1676 243	1718 240	1760 5	1802 228	1844 155	1886 246	1928 3
1677 160	1719 10	1761 249	1803 240	1845 2	1887 161	1929 4
1678 225	1720 11	1762 6	1804 237	1846 3	1888 225	1930 155
1679 15	1721 12	1763 244	1805 226	1847 4	1889 237	1931 155
1680 233	1722 225	1764 7	1806 227	1848 233	1890 1	1932 155
1681 16	1723 227	1765 236	1807 231	1849 239	1891 226	1933 155
1682 17	1724 13	1766 8	1808 236	1850 238	1892 2	1934 155
1683 229	1725 232	1767 245	1809 5	1851 229	1893 3	1935 155
1684 18	1726 14	1768 242	1810 229	1852 225	1894 4	1936 155
1685 19	1727 15	1769 9	1811 6	1853 128	1895 167	1937 155
1686 20	1728 239	1770 225	1812 7	1854 5	1896 5	1938 155
1687 21	1729 16	1771 243	1813 8	1855 160	1897 6	1939 155
1688 22	1730 17	1772 10	1814 9	1856 6	1898 247	
1689 23	1731 243	1773 239	1815 244	1857 7	1899 7	
1690 25	1732 18	1774 11	1816 10	1858 8	1900 155	
1691 26	1733 233	1775 12	1817 11	1859 9	1901 236	
1692 167	1734 19	1776 13	1818 12	1860 243	1902 8	
1693 172	1735 229	1777 233	1819 243	1861 10	1903 229	

4. STANDARD COMPRESSION TYPE 2 HUFFMAN ENCODE/DECODE TABLES

The following encode/decode tables are optimized for English-language program description text. These tables correspond to `multiple_string_structure()` with `compression_type` value 0x02, and `mode` equal to 0xFF.

Table C6 English-language Program Description Encode Table

Prior Symbol: 0 Symbol: 27 Code: 1110000	Prior Symbol: '' Symbol: 'C' Code: 111100	Prior Symbol: '' Symbol: '' Code: 1
Prior Symbol: 0 Symbol: "" Code: 111001	Prior Symbol: '' Symbol: 'D' Code: 1111010	Prior Symbol: '' Symbol: "" Code: 01
Prior Symbol: 0 Symbol: 'A' Code: 010	Prior Symbol: '' Symbol: 'E' Code: 0100011	Prior Symbol: '' Symbol: 27 Code: 10
Prior Symbol: 0 Symbol: 'B' Code: 0011	Prior Symbol: '' Symbol: 'F' Code: 0101010	Prior Symbol: '' Symbol: '' Code: 1110
Prior Symbol: 0 Symbol: 'C' Code: 0111	Prior Symbol: '' Symbol: 'G' Code: 000010	Prior Symbol: '' Symbol: 'a' Code: 000
Prior Symbol: 0 Symbol: 'D' Code: 11101	Prior Symbol: '' Symbol: 'H' Code: 1111011	Prior Symbol: '' Symbol: 'b' Code: 0010
Prior Symbol: 0 Symbol: 'E' Code: 10010	Prior Symbol: '' Symbol: 'I' Code: 11001011	Prior Symbol: '' Symbol: 'c' Code: 110
Prior Symbol: 0 Symbol: 'F' Code: 10110	Prior Symbol: '' Symbol: 'J' Code: 000011	Prior Symbol: '' Symbol: 'd' Code: 0011
Prior Symbol: 0 Symbol: 'G' Code: 011011	Prior Symbol: '' Symbol: 'K' Code: 1100100	Prior Symbol: '' Symbol: 'e' Code: 0100
Prior Symbol: 0 Symbol: 'H' Code: 10111	Prior Symbol: '' Symbol: 'L' Code: 010110	Prior Symbol: '' Symbol: 'f' Code: 0101
Prior Symbol: 0 Symbol: 'I' Code: 011000	Prior Symbol: '' Symbol: 'M' Code: 101001	Prior Symbol: '' Symbol: 'i' Code: 1111
Prior Symbol: 0 Symbol: 'J' Code: 1100	Prior Symbol: '' Symbol: 'N' Code: 001100	Prior Symbol: '' Symbol: 's' Code: 011
Prior Symbol: 0 Symbol: 'K' Code: 00101	Prior Symbol: '' Symbol: 'O' Code: 10100001	Prior Symbol: '' Symbol: 0 Code: 1
Prior Symbol: 0 Symbol: 'L' Code: 10011	Prior Symbol: '' Symbol: 'P' Code: 001101	Prior Symbol: '' Symbol: 27 Code: 000
Prior Symbol: 0 Symbol: 'M' Code: 1111	Prior Symbol: '' Symbol: 'R' Code: 1111100	Prior Symbol: '' Symbol: '' Code: 01
Prior Symbol: 0 Symbol: 'N' Code: 00100	Prior Symbol: '' Symbol: 'S' Code: 01001	Prior Symbol: '' Symbol: "" Code: 0010
Prior Symbol: 0 Symbol: 'O' Code: 011001	Prior Symbol: '' Symbol: 'T' Code: 1100110	Prior Symbol: '' Symbol: 'J' Code: 00110
Prior Symbol: 0 Symbol: 'P' Code: 000	Prior Symbol: '' Symbol: 'U' Code: 111111011	Prior Symbol: '' Symbol: 'S' Code: 00111
Prior Symbol: 0 Symbol: 'R' Code: 1000	Prior Symbol: '' Symbol: 'V' Code: 111111100	Prior Symbol: '7' Symbol: 27 Code: 0
Prior Symbol: 0 Symbol: 'S' Code: 1010	Prior Symbol: '' Symbol: 'W' Code: 010000	Prior Symbol: '7' Symbol: '' Code: 1
Prior Symbol: 0 Symbol: 'T' Code: 1101	Prior Symbol: '' Symbol: 'Y' Code: 111111101	Prior Symbol: '0' Symbol: 27 Code: 100
Prior Symbol: 0 Symbol: 'V' Code: 1110001	Prior Symbol: '' Symbol: 'Z' Code: 1010000001	Prior Symbol: '0' Symbol: '' Code: 111
Prior Symbol: 0 Symbol: 'W' Code: 011010	Prior Symbol: '' Symbol: 'a' Code: 011	Prior Symbol: '0' Symbol: '0' Code: 00
Prior Symbol: 1 Symbol: 27 Code: 1	Prior Symbol: '' Symbol: 'b' Code: 10111	Prior Symbol: '0' Symbol: '7' Code: 101
Prior Symbol: 2 Symbol: 27 Code: 1	Prior Symbol: '' Symbol: 'c' Code: 10011	Prior Symbol: '0' Symbol: 's' Code: 01
Prior Symbol: 3 Symbol: 27 Code: 1	Prior Symbol: '' Symbol: 'd' Code: 10000	Prior Symbol: '0' Symbol: 't' Code: 110
Prior Symbol: 4 Symbol: 27 Code: 1	Prior Symbol: '' Symbol: 'e' Code: 100010	Prior Symbol: '1' Symbol: 27 Code: 111
Prior Symbol: 5 Symbol: 27 Code: 1	Prior Symbol: '' Symbol: 'f' Code: 11101	Prior Symbol: '1' Symbol: '' Code: 10
Prior Symbol: 6 Symbol: 27 Code: 1	Prior Symbol: '' Symbol: 'g' Code: 100011	Prior Symbol: '1' Symbol: '8' Code: 110
Prior Symbol: 7 Symbol: 27 Code: 1	Prior Symbol: '' Symbol: 'h' Code: 0001	Prior Symbol: '1' Symbol: '9' Code: 0
Prior Symbol: 8 Symbol: 27 Code: 1	Prior Symbol: '' Symbol: 'i' Code: 10101	Prior Symbol: '2' Symbol: 27 Code: 101
Prior Symbol: 9 Symbol: 27 Code: 1	Prior Symbol: '' Symbol: 'j' Code: 11001111	Prior Symbol: '2' Symbol: '' Code: 11
Prior Symbol: 10 Symbol: 27 Code: 1	Prior Symbol: '' Symbol: 'k' Code: 11111010	Prior Symbol: '2' Symbol: '2' Code: 0
Prior Symbol: 11 Symbol: 27 Code: 1	Prior Symbol: '' Symbol: 'l' Code: 010111	Prior Symbol: '2' Symbol: '6' Code: 100
Prior Symbol: 12 Symbol: 27 Code: 1	Prior Symbol: '' Symbol: 'm' Code: 00000	Prior Symbol: '3' Symbol: 27 Code: 10
Prior Symbol: 13 Symbol: 27 Code: 1	Prior Symbol: '' Symbol: 'n' Code: 1010001	Prior Symbol: '3' Symbol: '' Code: 0
Prior Symbol: 14 Symbol: 27 Code: 1	Prior Symbol: '' Symbol: 'o' Code: 0010	Prior Symbol: '3' Symbol: '0' Code: 11
Prior Symbol: 15 Symbol: 27 Code: 1	Prior Symbol: '' Symbol: 'p' Code: 10110	Prior Symbol: '4' Symbol: 27 Code: 10
Prior Symbol: 16 Symbol: 27 Code: 1	Prior Symbol: '' Symbol: 'q' Code: 110010101	Prior Symbol: '4' Symbol: '' Code: 11
Prior Symbol: 17 Symbol: 27 Code: 1	Prior Symbol: '' Symbol: 'r' Code: 00111	Prior Symbol: '4' Symbol: '' Code: 0
Prior Symbol: 18 Symbol: 27 Code: 1	Prior Symbol: '' Symbol: 's' Code: 11100	Prior Symbol: '5' Symbol: 27 Code: 11
Prior Symbol: 19 Symbol: 27 Code: 1	Prior Symbol: '' Symbol: 't' Code: 1101	Prior Symbol: '5' Symbol: '' Code: 10
Prior Symbol: 20 Symbol: 27 Code: 1	Prior Symbol: '' Symbol: 'u' Code: 11111011	Prior Symbol: '5' Symbol: '' Code: 0
Prior Symbol: 21 Symbol: 27 Code: 1	Prior Symbol: '' Symbol: 'v' Code: 111111100	Prior Symbol: '6' Symbol: 27 Code: 1
Prior Symbol: 22 Symbol: 27 Code: 1	Prior Symbol: '' Symbol: 'w' Code: 11000	Prior Symbol: '7' Symbol: 27 Code: 0
Prior Symbol: 23 Symbol: 27 Code: 1	Prior Symbol: '' Symbol: 'y' Code: 11001110	Prior Symbol: '7' Symbol: '' Code: 10
Prior Symbol: 24 Symbol: 27 Code: 1	Prior Symbol: '!' Symbol: 27 Code: 1	Prior Symbol: '7' Symbol: '' Code: 11
Prior Symbol: 25 Symbol: 27 Code: 1	Prior Symbol: "" Symbol: 0 Code: 000	Prior Symbol: '8' Symbol: 27 Code: 1
Prior Symbol: 26 Symbol: 27 Code: 1	Prior Symbol: "" Symbol: 27 Code: 10	Prior Symbol: '9' Symbol: 27 Code: 110
Prior Symbol: 27 Symbol: 27 Code: 1	Prior Symbol: "" Symbol: '' Code: 11	Prior Symbol: '9' Symbol: '' Code: 111
Prior Symbol: 28 Symbol: 27 Code: 1	Prior Symbol: "" Symbol: '' Code: 001	Prior Symbol: '9' Symbol: '5' Code: 00
Prior Symbol: 29 Symbol: 27 Code: 1	Prior Symbol: "" Symbol: 'H' Code: 010	Prior Symbol: '9' Symbol: '6' Code: 01
Prior Symbol: 30 Symbol: 27 Code: 1	Prior Symbol: "" Symbol: 'T' Code: 011	Prior Symbol: '9' Symbol: '8' Code: 10
Prior Symbol: 31 Symbol: 27 Code: 1	Prior Symbol: "" Symbol: '#' Symbol: 27 Code: 1	Prior Symbol: '' Symbol: '' Code: 0
Prior Symbol: '' Symbol: 27 Code: 101000001	Prior Symbol: '\$' Symbol: 27 Code: 1	Prior Symbol: '' Symbol: '' Code: 1
Prior Symbol: '' Symbol: "" Code: 111111010	Prior Symbol: '%' Symbol: 27 Code: 1	Prior Symbol: '' Symbol: 27 Code: 0
Prior Symbol: '' Symbol: '{' Code: 1111111100	Prior Symbol: '&' Symbol: 27 Code: 1	Prior Symbol: '' Symbol: '' Code: 1
Prior Symbol: '' Symbol: ':' Code: 11111111110	Prior Symbol: "" Symbol: 27 Code: 00	Prior Symbol: '<' Symbol: 27 Code: 1
Prior Symbol: '' Symbol: ']' Code: 11111111111	Prior Symbol: "" Symbol: '' Code: 010	Prior Symbol: '=' Symbol: 27 Code: 1
Prior Symbol: '' Symbol: '1' Code: 0101011	Prior Symbol: "" Symbol: 's' Code: 1	Prior Symbol: '>' Symbol: 27 Code: 1
Prior Symbol: '' Symbol: '2' Code: 0100010	Prior Symbol: "" Symbol: 't' Code: 011	Prior Symbol: '?' Symbol: 27 Code: 0
Prior Symbol: '' Symbol: '3' Code: 1111111101	Prior Symbol: '(' Symbol: 27 Code: 1	Prior Symbol: '?' Symbol: '' Code: 1
Prior Symbol: '' Symbol: '4' Code: 110010100	Prior Symbol: ')' Symbol: 27 Code: 1	Prior Symbol: '@' Symbol: 27 Code: 1
Prior Symbol: '' Symbol: '5' Code: 11111111110	Prior Symbol: ']' Symbol: '' Code: 0	Prior Symbol: 'A' Symbol: 27 Code: 10010
Prior Symbol: '' Symbol: '7' Code: 1010000000	Prior Symbol: "" Symbol: 27 Code: 1	Prior Symbol: 'A' Symbol: '' Code: 11
Prior Symbol: '' Symbol: 'A' Code: 10010	Prior Symbol: '+' Symbol: 27 Code: 1	Prior Symbol: 'A' Symbol: 'd' Code: 10011
Prior Symbol: '' Symbol: 'B' Code: 010100	Prior Symbol: '' Symbol: 27 Code: 00	Prior Symbol: 'A' Symbol: 'f' Code: 101000

Prior Symbol: 'A' Symbol: 'l' Code: 00
 Prior Symbol: 'A' Symbol: 'm' Code: 10101
 Prior Symbol: 'A' Symbol: 'n' Code: 01
 Prior Symbol: 'A' Symbol: 'r' Code: 1011
 Prior Symbol: 'A' Symbol: 's' Code: 10000
 Prior Symbol: 'A' Symbol: 't' Code: 10001
 Prior Symbol: 'A' Symbol: 'u' Code: 101001
 Prior Symbol: 'B' Symbol: 27 Code: 10010
 Prior Symbol: 'B' Symbol: 'a' Code: 101
 Prior Symbol: 'B' Symbol: 'e' Code: 111
 Prior Symbol: 'B' Symbol: 'f' Code: 00
 Prior Symbol: 'B' Symbol: 'g' Code: 10011
 Prior Symbol: 'B' Symbol: 'o' Code: 110
 Prior Symbol: 'B' Symbol: 'y' Code: 01
 Prior Symbol: 'B' Symbol: 'z' Code: 1000
 Prior Symbol: 'C' Symbol: 27 Code: 01110
 Prior Symbol: 'C' Symbol: 'a' Code: 00
 Prior Symbol: 'C' Symbol: 'i' Code: 10
 Prior Symbol: 'C' Symbol: 'j' Code: 01111
 Prior Symbol: 'C' Symbol: 'l' Code: 110
 Prior Symbol: 'C' Symbol: 'o' Code: 111
 Prior Symbol: 'C' Symbol: 'r' Code: 0101
 Prior Symbol: 'C' Symbol: 'u' Code: 0110
 Prior Symbol: 'C' Symbol: 'y' Code: 0100
 Prior Symbol: 'D' Symbol: 27 Code: 1111
 Prior Symbol: 'D' Symbol: 'a' Code: 01
 Prior Symbol: 'D' Symbol: 'e' Code: 100
 Prior Symbol: 'D' Symbol: 'f' Code: 00
 Prior Symbol: 'D' Symbol: 'o' Code: 101
 Prior Symbol: 'D' Symbol: 'r' Code: 1101
 Prior Symbol: 'D' Symbol: 'u' Code: 1110
 Prior Symbol: 'D' Symbol: 'y' Code: 1100
 Prior Symbol: 'E' Symbol: 27 Code: 10
 Prior Symbol: 'E' Symbol: 'a' Code: 0110
 Prior Symbol: 'E' Symbol: 'd' Code: 000
 Prior Symbol: 'E' Symbol: 'f' Code: 0111
 Prior Symbol: 'E' Symbol: 'g' Code: 001
 Prior Symbol: 'E' Symbol: 'h' Code: 1100
 Prior Symbol: 'E' Symbol: 'l' Code: 111
 Prior Symbol: 'E' Symbol: 's' Code: 010
 Prior Symbol: 'E' Symbol: 'v' Code: 1101
 Prior Symbol: 'F' Symbol: 27 Code: 00
 Prior Symbol: 'F' Symbol: 'e' Code: 100
 Prior Symbol: 'F' Symbol: 'f' Code: 101
 Prior Symbol: 'F' Symbol: 'o' Code: 01
 Prior Symbol: 'F' Symbol: 't' Code: 11
 Prior Symbol: 'G' Symbol: 27 Code: 000
 Prior Symbol: 'G' Symbol: 'a' Code: 110
 Prior Symbol: 'G' Symbol: 'e' Code: 01
 Prior Symbol: 'G' Symbol: 'f' Code: 100
 Prior Symbol: 'G' Symbol: 'i' Code: 001
 Prior Symbol: 'G' Symbol: 'o' Code: 1011
 Prior Symbol: 'G' Symbol: 'r' Code: 111
 Prior Symbol: 'G' Symbol: 'u' Code: 1010
 Prior Symbol: 'H' Symbol: 27 Code: 010
 Prior Symbol: 'H' Symbol: 'a' Code: 00
 Prior Symbol: 'H' Symbol: 'e' Code: 011
 Prior Symbol: 'H' Symbol: 'f' Code: 110
 Prior Symbol: 'H' Symbol: 'o' Code: 10
 Prior Symbol: 'H' Symbol: 'u' Code: 111
 Prior Symbol: 'I' Symbol: 27 Code: 011
 Prior Symbol: 'I' Symbol: ' ' Code: 000
 Prior Symbol: 'I' Symbol: '.' Code: 100
 Prior Symbol: 'I' Symbol: 'l' Code: 001
 Prior Symbol: 'I' Symbol: 'n' Code: 11
 Prior Symbol: 'I' Symbol: 'r' Code: 101
 Prior Symbol: 'I' Symbol: 's' Code: 010
 Prior Symbol: 'J' Symbol: 27 Code: 1000
 Prior Symbol: 'J' Symbol: ' ' Code: 1001
 Prior Symbol: 'J' Symbol: 'a' Code: 111
 Prior Symbol: 'J' Symbol: 'e' Code: 1101
 Prior Symbol: 'J' Symbol: 'f' Code: 1100
 Prior Symbol: 'J' Symbol: 'o' Code: 0
 Prior Symbol: 'J' Symbol: 't' Code: 101
 Prior Symbol: 'K' Symbol: 27 Code: 111
 Prior Symbol: 'K' Symbol: 'a' Code: 100
 Prior Symbol: 'K' Symbol: 'e' Code: 0
 Prior Symbol: 'K' Symbol: 'f' Code: 101
 Prior Symbol: 'K' Symbol: 'r' Code: 110
 Prior Symbol: 'L' Symbol: 27 Code: 0110

Prior Symbol: 'L' Symbol: 'a' Code: 11
 Prior Symbol: 'L' Symbol: 'e' Code: 00
 Prior Symbol: 'L' Symbol: 'f' Code: 0111
 Prior Symbol: 'L' Symbol: 'o' Code: 10
 Prior Symbol: 'L' Symbol: 'u' Code: 010
 Prior Symbol: 'M' Symbol: 27 Code: 11010
 Prior Symbol: 'M' Symbol: 'a' Code: 0
 Prior Symbol: 'M' Symbol: 'c' Code: 11011
 Prior Symbol: 'M' Symbol: 'e' Code: 1111
 Prior Symbol: 'M' Symbol: 'f' Code: 10
 Prior Symbol: 'M' Symbol: 'o' Code: 1100
 Prior Symbol: 'M' Symbol: 'r' Code: 1110
 Prior Symbol: 'N' Symbol: 27 Code: 1100
 Prior Symbol: 'N' Symbol: 'a' Code: 111
 Prior Symbol: 'N' Symbol: 'e' Code: 0
 Prior Symbol: 'N' Symbol: 'f' Code: 1101
 Prior Symbol: 'N' Symbol: 'o' Code: 10
 Prior Symbol: 'O' Symbol: 27 Code: 10
 Prior Symbol: 'O' Symbol: ' ' Code: 010
 Prior Symbol: 'O' Symbol: 'f' Code: 110
 Prior Symbol: 'O' Symbol: 'h' Code: 011
 Prior Symbol: 'O' Symbol: 'r' Code: 111
 Prior Symbol: 'O' Symbol: 's' Code: 00
 Prior Symbol: 'P' Symbol: 27 Code: 10010
 Prior Symbol: 'P' Symbol: 'a' Code: 0
 Prior Symbol: 'P' Symbol: 'e' Code: 111
 Prior Symbol: 'P' Symbol: 'f' Code: 10011
 Prior Symbol: 'P' Symbol: 'i' Code: 1000
 Prior Symbol: 'P' Symbol: 'l' Code: 1101
 Prior Symbol: 'P' Symbol: 'o' Code: 101
 Prior Symbol: 'P' Symbol: 'r' Code: 1100
 Prior Symbol: 'Q' Symbol: 27 Code: 1
 Prior Symbol: 'R' Symbol: 27 Code: 0000
 Prior Symbol: 'R' Symbol: ' ' Code: 0001
 Prior Symbol: 'R' Symbol: 'a' Code: 01
 Prior Symbol: 'R' Symbol: 'e' Code: 10
 Prior Symbol: 'R' Symbol: 'f' Code: 001
 Prior Symbol: 'R' Symbol: 'o' Code: 11
 Prior Symbol: 'S' Symbol: 27 Code: 1011
 Prior Symbol: 'S' Symbol: ' ' Code: 0001
 Prior Symbol: 'S' Symbol: 'a' Code: 100
 Prior Symbol: 'S' Symbol: 'c' Code: 0010
 Prior Symbol: 'S' Symbol: 'e' Code: 1110
 Prior Symbol: 'S' Symbol: 'h' Code: 110
 Prior Symbol: 'S' Symbol: 'i' Code: 0011
 Prior Symbol: 'S' Symbol: 'l' Code: 1111
 Prior Symbol: 'S' Symbol: 't' Code: 01
 Prior Symbol: 'S' Symbol: 'u' Code: 1010
 Prior Symbol: 'S' Symbol: 'v' Code: 00000
 Prior Symbol: 'S' Symbol: 'y' Code: 00001
 Prior Symbol: 'T' Symbol: 27 Code: 1010
 Prior Symbol: 'T' Symbol: 'v' Code: 1000
 Prior Symbol: 'T' Symbol: 'a' Code: 1001
 Prior Symbol: 'T' Symbol: 'e' Code: 11010
 Prior Symbol: 'T' Symbol: 'h' Code: 0
 Prior Symbol: 'T' Symbol: 'i' Code: 1011
 Prior Symbol: 'T' Symbol: 'o' Code: 111
 Prior Symbol: 'T' Symbol: 'r' Code: 1100
 Prior Symbol: 'T' Symbol: 'w' Code: 11011
 Prior Symbol: 'U' Symbol: 27 Code: 10
 Prior Symbol: 'U' Symbol: ' ' Code: 0
 Prior Symbol: 'U' Symbol: 'n' Code: 11
 Prior Symbol: 'V' Symbol: 27 Code: 111
 Prior Symbol: 'V' Symbol: ' ' Code: 10
 Prior Symbol: 'V' Symbol: 'e' Code: 110
 Prior Symbol: 'V' Symbol: 'o' Code: 0
 Prior Symbol: 'W' Symbol: 27 Code: 010
 Prior Symbol: 'W' Symbol: 'a' Code: 111
 Prior Symbol: 'W' Symbol: 'e' Code: 110
 Prior Symbol: 'W' Symbol: 'h' Code: 011
 Prior Symbol: 'W' Symbol: 'i' Code: 10
 Prior Symbol: 'W' Symbol: 'o' Code: 00
 Prior Symbol: 'X' Symbol: 27 Code: 1
 Prior Symbol: 'Y' Symbol: 27 Code: 0
 Prior Symbol: 'Y' Symbol: 'o' Code: 1
 Prior Symbol: 'Z' Symbol: 27 Code: 1
 Prior Symbol: 'Z' Symbol: 27 Code: 1
 Prior Symbol: 'Z' Symbol: 27 Code: 1
 Prior Symbol: 'Z' Symbol: 27 Code: 1
 Prior Symbol: 'Z' Symbol: 27 Code: 1
 Prior Symbol: 'Z' Symbol: 27 Code: 1

Prior Symbol: ' ' Symbol: 27 Code: 1
 Prior Symbol: ' ' Symbol: 27 Code: 1
 Prior Symbol: 'a' Symbol: 27 Code: 1110011001
 Prior Symbol: 'a' Symbol: ' ' Code: 101
 Prior Symbol: 'a' Symbol: ' ' Code: 111001110
 Prior Symbol: 'a' Symbol: ' ' Code: 1110010
 Prior Symbol: 'a' Symbol: 'b' Code: 001011
 Prior Symbol: 'a' Symbol: 'c' Code: 11001
 Prior Symbol: 'a' Symbol: 'd' Code: 00111
 Prior Symbol: 'a' Symbol: 'e' Code: 0011001
 Prior Symbol: 'a' Symbol: 'f' Code: 001010
 Prior Symbol: 'a' Symbol: 'g' Code: 00100
 Prior Symbol: 'a' Symbol: 'h' Code: 001100010
 Prior Symbol: 'a' Symbol: 'i' Code: 111000
 Prior Symbol: 'a' Symbol: 'k' Code: 110000
 Prior Symbol: 'a' Symbol: 'l' Code: 1101
 Prior Symbol: 'a' Symbol: 'm' Code: 11101
 Prior Symbol: 'a' Symbol: 'n' Code: 01
 Prior Symbol: 'a' Symbol: 'o' Code: 001100011
 Prior Symbol: 'a' Symbol: 'p' Code: 00000
 Prior Symbol: 'a' Symbol: 'r' Code: 100
 Prior Symbol: 'a' Symbol: 's' Code: 0001
 Prior Symbol: 'a' Symbol: 't' Code: 1111
 Prior Symbol: 'a' Symbol: 'u' Code: 110001
 Prior Symbol: 'a' Symbol: 'v' Code: 001101
 Prior Symbol: 'a' Symbol: 'w' Code: 111001111
 Prior Symbol: 'a' Symbol: 'x' Code: 111001100
 Prior Symbol: 'a' Symbol: 'y' Code: 00001
 Prior Symbol: 'a' Symbol: 'z' Code: 00110000
 Prior Symbol: 'b' Symbol: 27 Code: 101000
 Prior Symbol: 'b' Symbol: ' ' Code: 0101
 Prior Symbol: 'b' Symbol: '.' Code: 101001
 Prior Symbol: 'b' Symbol: 'a' Code: 100
 Prior Symbol: 'b' Symbol: 'e' Code: 101010
 Prior Symbol: 'b' Symbol: 'd' Code: 1010110
 Prior Symbol: 'b' Symbol: 'e' Code: 00
 Prior Symbol: 'b' Symbol: 'f' Code: 1011
 Prior Symbol: 'b' Symbol: 'i' Code: 0100
 Prior Symbol: 'b' Symbol: 'o' Code: 110
 Prior Symbol: 'b' Symbol: 'u' Code: 1110
 Prior Symbol: 'b' Symbol: 's' Code: 1010111
 Prior Symbol: 'b' Symbol: 'u' Code: 1111
 Prior Symbol: 'b' Symbol: 'y' Code: 011
 Prior Symbol: 'c' Symbol: 27 Code: 00010
 Prior Symbol: 'c' Symbol: ' ' Code: 10000
 Prior Symbol: 'c' Symbol: ' ' Code: 010000
 Prior Symbol: 'c' Symbol: '.' Code: 0100011
 Prior Symbol: 'c' Symbol: 'd' Code: 0100110
 Prior Symbol: 'c' Symbol: 'a' Code: 110
 Prior Symbol: 'c' Symbol: 'c' Code: 010010
 Prior Symbol: 'c' Symbol: 'e' Code: 011
 Prior Symbol: 'c' Symbol: 'h' Code: 111
 Prior Symbol: 'c' Symbol: 'f' Code: 0101
 Prior Symbol: 'c' Symbol: 'k' Code: 1001
 Prior Symbol: 'c' Symbol: 'l' Code: 10001
 Prior Symbol: 'c' Symbol: 'o' Code: 101
 Prior Symbol: 'c' Symbol: 'q' Code: 0100010
 Prior Symbol: 'c' Symbol: 'r' Code: 00011
 Prior Symbol: 'c' Symbol: 't' Code: 001
 Prior Symbol: 'c' Symbol: 'u' Code: 0000
 Prior Symbol: 'c' Symbol: 'y' Code: 0100111
 Prior Symbol: 'd' Symbol: 27 Code: 1010001
 Prior Symbol: 'd' Symbol: ' ' Code: 11
 Prior Symbol: 'd' Symbol: ' ' Code: 01111010
 Prior Symbol: 'd' Symbol: ' ' Code: 101011
 Prior Symbol: 'd' Symbol: ' ' Code: 0100
 Prior Symbol: 'd' Symbol: 'a' Code: 01111011
 Prior Symbol: 'd' Symbol: 'a' Code: 1000
 Prior Symbol: 'd' Symbol: 'd' Code: 01010
 Prior Symbol: 'd' Symbol: 'e' Code: 00
 Prior Symbol: 'd' Symbol: 'f' Code: 10100000
 Prior Symbol: 'd' Symbol: 'g' Code: 10101011
 Prior Symbol: 'd' Symbol: 'i' Code: 1011
 Prior Symbol: 'd' Symbol: 'l' Code: 011111
 Prior Symbol: 'd' Symbol: 'm' Code: 10100001
 Prior Symbol: 'd' Symbol: 'n' Code: 1010100
 Prior Symbol: 'd' Symbol: 'o' Code: 0110
 Prior Symbol: 'd' Symbol: 'r' Code: 01110
 Prior Symbol: 'd' Symbol: 's' Code: 1001
 Prior Symbol: 'd' Symbol: 'u' Code: 101001

Prior Symbol: 'd' Symbol: 'v' Code: 0111100
 Prior Symbol: 'd' Symbol: 'w' Code: 10101010
 Prior Symbol: 'd' Symbol: 'y' Code: 01011
 Prior Symbol: 'e' Symbol: 27 Code: 101110011
 Prior Symbol: 'e' Symbol: '' Code: 111
 Prior Symbol: 'e' Symbol: ''' Code: 10111010
 Prior Symbol: 'e' Symbol: 'j' Code: 100110000
 Prior Symbol: 'e' Symbol: '.' Code: 000111
 Prior Symbol: 'e' Symbol: ':' Code: 10011001
 Prior Symbol: 'e' Symbol: ';' Code: 00110
 Prior Symbol: 'e' Symbol: '/' Code: 10011010
 Prior Symbol: 'e' Symbol: 'd' Code: 1000
 Prior Symbol: 'e' Symbol: 'b' Code: 0001100
 Prior Symbol: 'e' Symbol: 'c' Code: 10010
 Prior Symbol: 'e' Symbol: 'k' Code: 0000
 Prior Symbol: 'e' Symbol: 'e' Code: 10100
 Prior Symbol: 'e' Symbol: 'f' Code: 10111011
 Prior Symbol: 'e' Symbol: 'g' Code: 0001101
 Prior Symbol: 'e' Symbol: 'h' Code: 100110001
 Prior Symbol: 'e' Symbol: 'i' Code: 000100
 Prior Symbol: 'e' Symbol: 'k' Code: 10011011
 Prior Symbol: 'e' Symbol: 'l' Code: 0010
 Prior Symbol: 'e' Symbol: 'm' Code: 100111
 Prior Symbol: 'e' Symbol: 'n' Code: 010
 Prior Symbol: 'e' Symbol: 'o' Code: 001110
 Prior Symbol: 'e' Symbol: 'p' Code: 001111
 Prior Symbol: 'e' Symbol: 'r' Code: 110
 Prior Symbol: 'e' Symbol: 's' Code: 011
 Prior Symbol: 'e' Symbol: 't' Code: 10101
 Prior Symbol: 'e' Symbol: 'u' Code: 101110010
 Prior Symbol: 'e' Symbol: 'v' Code: 101100
 Prior Symbol: 'e' Symbol: 'w' Code: 101111
 Prior Symbol: 'e' Symbol: 'x' Code: 000101
 Prior Symbol: 'e' Symbol: 'y' Code: 101101
 Prior Symbol: 'e' Symbol: 'z' Code: 10111000
 Prior Symbol: 'f' Symbol: 27 Code: 1110111
 Prior Symbol: 'f' Symbol: '' Code: 10
 Prior Symbol: 'f' Symbol: '.' Code: 1110110
 Prior Symbol: 'f' Symbol: 'a' Code: 1111
 Prior Symbol: 'f' Symbol: 'e' Code: 000
 Prior Symbol: 'f' Symbol: 'f' Code: 0101
 Prior Symbol: 'f' Symbol: 'i' Code: 001
 Prior Symbol: 'f' Symbol: 'j' Code: 111010
 Prior Symbol: 'f' Symbol: 'o' Code: 110
 Prior Symbol: 'f' Symbol: 'r' Code: 011
 Prior Symbol: 'f' Symbol: 't' Code: 0100
 Prior Symbol: 'f' Symbol: 'u' Code: 11100
 Prior Symbol: 'g' Symbol: 27 Code: 1111010
 Prior Symbol: 'g' Symbol: '' Code: 10
 Prior Symbol: 'g' Symbol: ''' Code: 1111011
 Prior Symbol: 'g' Symbol: '.' Code: 111110
 Prior Symbol: 'g' Symbol: ':' Code: 0101010
 Prior Symbol: 'g' Symbol: ';' Code: 01011
 Prior Symbol: 'g' Symbol: 'a' Code: 1110
 Prior Symbol: 'g' Symbol: 'e' Code: 00
 Prior Symbol: 'g' Symbol: 'g' Code: 0101011
 Prior Symbol: 'g' Symbol: 'h' Code: 011
 Prior Symbol: 'g' Symbol: 'i' Code: 1101
 Prior Symbol: 'g' Symbol: 'l' Code: 111100
 Prior Symbol: 'g' Symbol: 'o' Code: 0100
 Prior Symbol: 'g' Symbol: 'r' Code: 111111
 Prior Symbol: 'g' Symbol: 's' Code: 11000
 Prior Symbol: 'g' Symbol: 'u' Code: 11001
 Prior Symbol: 'g' Symbol: 'y' Code: 010100
 Prior Symbol: 'h' Symbol: 27 Code: 1011100
 Prior Symbol: 'h' Symbol: '' Code: 100
 Prior Symbol: 'h' Symbol: ''' Code: 10101000
 Prior Symbol: 'h' Symbol: '.' Code: 10101001
 Prior Symbol: 'h' Symbol: ':' Code: 10101011
 Prior Symbol: 'h' Symbol: ';' Code: 101001
 Prior Symbol: 'h' Symbol: 'a' Code: 011
 Prior Symbol: 'h' Symbol: 'e' Code: 11
 Prior Symbol: 'h' Symbol: 'i' Code: 00
 Prior Symbol: 'h' Symbol: 'n' Code: 101011
 Prior Symbol: 'h' Symbol: 'o' Code: 010
 Prior Symbol: 'h' Symbol: 'r' Code: 101111
 Prior Symbol: 'h' Symbol: 's' Code: 10101010
 Prior Symbol: 'h' Symbol: 't' Code: 10110
 Prior Symbol: 'h' Symbol: 'u' Code: 101000
 Prior Symbol: 'h' Symbol: 'y' Code: 1011101

Prior Symbol: 'i' Symbol: 27 Code: 00011101
 Prior Symbol: 'i' Symbol: '' Code: 0001111
 Prior Symbol: 'i' Symbol: '.' Code: 100110100
 Prior Symbol: 'i' Symbol: ':' Code: 100110000
 Prior Symbol: 'i' Symbol: 'a' Code: 11010
 Prior Symbol: 'i' Symbol: 'b' Code: 100110101
 Prior Symbol: 'i' Symbol: 'c' Code: 1111
 Prior Symbol: 'i' Symbol: 'd' Code: 10000
 Prior Symbol: 'i' Symbol: 'e' Code: 1110
 Prior Symbol: 'i' Symbol: 'f' Code: 100111
 Prior Symbol: 'i' Symbol: 'g' Code: 10010
 Prior Symbol: 'i' Symbol: 'k' Code: 10011011
 Prior Symbol: 'i' Symbol: 'l' Code: 1100
 Prior Symbol: 'i' Symbol: 'm' Code: 10001
 Prior Symbol: 'i' Symbol: 'n' Code: 01
 Prior Symbol: 'i' Symbol: 'o' Code: 11011
 Prior Symbol: 'i' Symbol: 'p' Code: 000110
 Prior Symbol: 'i' Symbol: 'r' Code: 0000
 Prior Symbol: 'i' Symbol: 's' Code: 101
 Prior Symbol: 'i' Symbol: 't' Code: 001
 Prior Symbol: 'i' Symbol: 'u' Code: 00010
 Prior Symbol: 'i' Symbol: 'x' Code: 00011100
 Prior Symbol: 'i' Symbol: 'z' Code: 10011001
 Prior Symbol: 'j' Symbol: 27 Code: 000
 Prior Symbol: 'j' Symbol: 'a' Code: 001
 Prior Symbol: 'j' Symbol: 'e' Code: 010
 Prior Symbol: 'j' Symbol: 'o' Code: 1
 Prior Symbol: 'j' Symbol: 'u' Code: 011
 Prior Symbol: 'k' Symbol: 27 Code: 0000
 Prior Symbol: 'k' Symbol: '' Code: 01
 Prior Symbol: 'k' Symbol: ''' Code: 10000
 Prior Symbol: 'k' Symbol: '.' Code: 10011
 Prior Symbol: 'k' Symbol: ':' Code: 0001
 Prior Symbol: 'k' Symbol: 'e' Code: 11
 Prior Symbol: 'k' Symbol: 'l' Code: 101
 Prior Symbol: 'k' Symbol: 'r' Code: 100100
 Prior Symbol: 'k' Symbol: 'n' Code: 10001
 Prior Symbol: 'k' Symbol: 's' Code: 001
 Prior Symbol: 'k' Symbol: 'y' Code: 100101
 Prior Symbol: 'l' Symbol: 27 Code: 0011100
 Prior Symbol: 'l' Symbol: '' Code: 110
 Prior Symbol: 'l' Symbol: '.' Code: 00111100
 Prior Symbol: 'l' Symbol: ':' Code: 001101
 Prior Symbol: 'l' Symbol: ';' Code: 00111101
 Prior Symbol: 'l' Symbol: 'a' Code: 00100
 Prior Symbol: 'l' Symbol: 'd' Code: 000
 Prior Symbol: 'l' Symbol: 'b' Code: 0011101
 Prior Symbol: 'l' Symbol: 'c' Code: 00111111
 Prior Symbol: 'l' Symbol: 'd' Code: 10111
 Prior Symbol: 'l' Symbol: 'e' Code: 111
 Prior Symbol: 'l' Symbol: 'f' Code: 010110
 Prior Symbol: 'l' Symbol: 'i' Code: 011
 Prior Symbol: 'l' Symbol: 'k' Code: 10110110
 Prior Symbol: 'l' Symbol: 'l' Code: 100
 Prior Symbol: 'l' Symbol: 'm' Code: 010111
 Prior Symbol: 'l' Symbol: 'n' Code: 00111110
 Prior Symbol: 'l' Symbol: 'o' Code: 1010
 Prior Symbol: 'l' Symbol: 'p' Code: 00101
 Prior Symbol: 'l' Symbol: 'r' Code: 10110111
 Prior Symbol: 'l' Symbol: 's' Code: 01010
 Prior Symbol: 'l' Symbol: 't' Code: 001100
 Prior Symbol: 'l' Symbol: 'u' Code: 1011010
 Prior Symbol: 'l' Symbol: 'v' Code: 101100
 Prior Symbol: 'l' Symbol: 'y' Code: 0100
 Prior Symbol: 'm' Symbol: 27 Code: 101010
 Prior Symbol: 'm' Symbol: '' Code: 111
 Prior Symbol: 'm' Symbol: ''' Code: 1010110
 Prior Symbol: 'm' Symbol: '.' Code: 110101
 Prior Symbol: 'm' Symbol: ':' Code: 1010111
 Prior Symbol: 'm' Symbol: ';' Code: 00
 Prior Symbol: 'm' Symbol: 'a' Code: 10100
 Prior Symbol: 'm' Symbol: 'b' Code: 10100
 Prior Symbol: 'm' Symbol: 'e' Code: 01
 Prior Symbol: 'm' Symbol: 'i' Code: 1100
 Prior Symbol: 'm' Symbol: 'm' Code: 10110
 Prior Symbol: 'm' Symbol: 'o' Code: 1000
 Prior Symbol: 'm' Symbol: 'p' Code: 1001
 Prior Symbol: 'm' Symbol: 's' Code: 10111
 Prior Symbol: 'm' Symbol: 'u' Code: 11011
 Prior Symbol: 'm' Symbol: 'y' Code: 110100
 Prior Symbol: 'm' Symbol: 27 Code: 0100000

Prior Symbol: 'n' Symbol: '' Code: 10
 Prior Symbol: 'n' Symbol: ''' Code: 0100011
 Prior Symbol: 'n' Symbol: '.' Code: 111100
 Prior Symbol: 'n' Symbol: ':' Code: 011011010
 Prior Symbol: 'n' Symbol: ';' Code: 01100
 Prior Symbol: 'n' Symbol: 'j' Code: 011011011
 Prior Symbol: 'n' Symbol: 'a' Code: 11111
 Prior Symbol: 'n' Symbol: 'b' Code: 011011100
 Prior Symbol: 'n' Symbol: 'c' Code: 01001
 Prior Symbol: 'n' Symbol: 'd' Code: 110
 Prior Symbol: 'n' Symbol: 'e' Code: 001
 Prior Symbol: 'n' Symbol: 'f' Code: 01000101
 Prior Symbol: 'n' Symbol: 'g' Code: 000
 Prior Symbol: 'n' Symbol: 'i' Code: 01111
 Prior Symbol: 'n' Symbol: 'l' Code: 011011101
 Prior Symbol: 'n' Symbol: 'k' Code: 1111010
 Prior Symbol: 'n' Symbol: 'l' Code: 01101100
 Prior Symbol: 'n' Symbol: 'm' Code: 011011110
 Prior Symbol: 'n' Symbol: 'n' Code: 01110
 Prior Symbol: 'n' Symbol: 'o' Code: 1111011
 Prior Symbol: 'n' Symbol: 'r' Code: 011011111
 Prior Symbol: 'n' Symbol: 's' Code: 0101
 Prior Symbol: 'n' Symbol: 't' Code: 1110
 Prior Symbol: 'n' Symbol: 'u' Code: 0100001
 Prior Symbol: 'n' Symbol: 'v' Code: 0110100
 Prior Symbol: 'n' Symbol: 'y' Code: 0110101
 Prior Symbol: 'o' Symbol: 27 Code: 101010011
 Prior Symbol: 'o' Symbol: '' Code: 001
 Prior Symbol: 'o' Symbol: '.' Code: 01001111
 Prior Symbol: 'o' Symbol: ':' Code: 01001110
 Prior Symbol: 'o' Symbol: ';' Code: 0100110
 Prior Symbol: 'o' Symbol: 'B' Code: 101010010
 Prior Symbol: 'o' Symbol: 'a' Code: 100001
 Prior Symbol: 'o' Symbol: 'b' Code: 110111
 Prior Symbol: 'o' Symbol: 'c' Code: 100000
 Prior Symbol: 'o' Symbol: 'd' Code: 110101
 Prior Symbol: 'o' Symbol: 'e' Code: 1010101
 Prior Symbol: 'o' Symbol: 'f' Code: 000
 Prior Symbol: 'o' Symbol: 'g' Code: 1101000
 Prior Symbol: 'o' Symbol: 'h' Code: 1101001
 Prior Symbol: 'o' Symbol: 'i' Code: 110101
 Prior Symbol: 'o' Symbol: 'k' Code: 010010
 Prior Symbol: 'o' Symbol: 'l' Code: 0101
 Prior Symbol: 'o' Symbol: 'm' Code: 1100
 Prior Symbol: 'o' Symbol: 'n' Code: 111
 Prior Symbol: 'o' Symbol: 'o' Code: 10100
 Prior Symbol: 'o' Symbol: 'p' Code: 01000
 Prior Symbol: 'o' Symbol: 'r' Code: 011
 Prior Symbol: 'o' Symbol: 's' Code: 10001
 Prior Symbol: 'o' Symbol: 't' Code: 10010
 Prior Symbol: 'o' Symbol: 'u' Code: 1011
 Prior Symbol: 'o' Symbol: 'v' Code: 101011
 Prior Symbol: 'o' Symbol: 'w' Code: 10011
 Prior Symbol: 'o' Symbol: 'x' Code: 10101000
 Prior Symbol: 'o' Symbol: 'y' Code: 1101100
 Prior Symbol: 'p' Symbol: 27 Code: 011011
 Prior Symbol: 'p' Symbol: '' Code: 000
 Prior Symbol: 'p' Symbol: '.' Code: 1010010
 Prior Symbol: 'p' Symbol: ':' Code: 101000
 Prior Symbol: 'p' Symbol: 'a' Code: 001
 Prior Symbol: 'p' Symbol: 'e' Code: 110
 Prior Symbol: 'p' Symbol: 'h' Code: 1111
 Prior Symbol: 'p' Symbol: 'i' Code: 1011
 Prior Symbol: 'p' Symbol: 'l' Code: 010
 Prior Symbol: 'p' Symbol: 'm' Code: 1010011
 Prior Symbol: 'p' Symbol: 'o' Code: 0111
 Prior Symbol: 'p' Symbol: 'p' Code: 11101
 Prior Symbol: 'p' Symbol: 'r' Code: 100
 Prior Symbol: 'p' Symbol: 's' Code: 01100
 Prior Symbol: 'p' Symbol: 't' Code: 11100
 Prior Symbol: 'p' Symbol: 'u' Code: 10101
 Prior Symbol: 'p' Symbol: 'y' Code: 011010
 Prior Symbol: 'q' Symbol: 27 Code: 0
 Prior Symbol: 'q' Symbol: 'u' Code: 1
 Prior Symbol: 'r' Symbol: 27 Code: 10011111
 Prior Symbol: 'r' Symbol: '' Code: 111
 Prior Symbol: 'r' Symbol: ''' Code: 1001110
 Prior Symbol: 'r' Symbol: 'j' Code: 1011100
 Prior Symbol: 'r' Symbol: 'l' Code: 1001100

Prior Symbol: 'r' Symbol: ':' Code: 11001100	Prior Symbol: 't' Symbol: ':' Code: 01111110	Prior Symbol: 'w' Symbol: 'h' Code: 000
Prior Symbol: 'r' Symbol: ':' Code: 10001	Prior Symbol: 't' Symbol: ':' Code: 01101	Prior Symbol: 'w' Symbol: 'i' Code: 10
Prior Symbol: 'r' Symbol: ':' Code: 100111101	Prior Symbol: 't' Symbol: ':' Code: 110000100	Prior Symbol: 'w' Symbol: 'l' Code: 0111110
Prior Symbol: 'r' Symbol: 'a' Code: 1101	Prior Symbol: 't' Symbol: 'a' Code: 0100	Prior Symbol: 'w' Symbol: 'm' Code: 0111111
Prior Symbol: 'r' Symbol: 'b' Code: 11001101	Prior Symbol: 't' Symbol: 'b' Code: 110000101	Prior Symbol: 'w' Symbol: 'n' Code: 11111
Prior Symbol: 'r' Symbol: 'c' Code: 100001	Prior Symbol: 't' Symbol: 'c' Code: 11000101	Prior Symbol: 'w' Symbol: 'o' Code: 110
Prior Symbol: 'r' Symbol: 'd' Code: 11000	Prior Symbol: 't' Symbol: 'e' Code: 101	Prior Symbol: 'w' Symbol: 'r' Code: 0110
Prior Symbol: 'r' Symbol: 'e' Code: 101	Prior Symbol: 't' Symbol: 'h' Code: 00	Prior Symbol: 'w' Symbol: 's' Code: 11110
Prior Symbol: 'r' Symbol: 'f' Code: 110011111	Prior Symbol: 't' Symbol: 'i' Code: 1101	Prior Symbol: 'x' Symbol: '27' Code: 10
Prior Symbol: 'r' Symbol: 'g' Code: 100101	Prior Symbol: 't' Symbol: 'l' Code: 01111101	Prior Symbol: 'x' Symbol: ':' Code: 0110
Prior Symbol: 'r' Symbol: 'i' Code: 010	Prior Symbol: 't' Symbol: 'm' Code: 011111111	Prior Symbol: 'x' Symbol: ';' Code: 0111
Prior Symbol: 'r' Symbol: 'k' Code: 110010	Prior Symbol: 't' Symbol: 'n' Code: 01111110	Prior Symbol: 'x' Symbol: '`' Code: 1100
Prior Symbol: 'r' Symbol: 'l' Code: 00100	Prior Symbol: 't' Symbol: 'o' Code: 100	Prior Symbol: 'x' Symbol: 'a' Code: 111
Prior Symbol: 'r' Symbol: 'm' Code: 00101	Prior Symbol: 't' Symbol: 'r' Code: 11001	Prior Symbol: 'x' Symbol: 'e' Code: 00
Prior Symbol: 'r' Symbol: 'n' Code: 01100	Prior Symbol: 't' Symbol: 's' Code: 0101	Prior Symbol: 'x' Symbol: 'i' Code: 010
Prior Symbol: 'r' Symbol: 'o' Code: 000	Prior Symbol: 't' Symbol: 't' Code: 01100	Prior Symbol: 'x' Symbol: 'l' Code: 1101
Prior Symbol: 'r' Symbol: 'p' Code: 11001110	Prior Symbol: 't' Symbol: 'u' Code: 01110	Prior Symbol: 'y' Symbol: '27' Code: 010010
Prior Symbol: 'r' Symbol: 'q' Code: 100110	Prior Symbol: 't' Symbol: 'v' Code: 1100000	Prior Symbol: 'y' Symbol: '`' Code: 1
Prior Symbol: 'r' Symbol: 's' Code: 0111	Prior Symbol: 't' Symbol: 'y' Code: 1100011	Prior Symbol: 'y' Symbol: '"' Code: 010010
Prior Symbol: 'r' Symbol: 't' Code: 0011	Prior Symbol: 'u' Symbol: '27' Code: 10011100	Prior Symbol: 'y' Symbol: ',' Code: 0001
Prior Symbol: 'r' Symbol: 'u' Code: 100000	Prior Symbol: 't' Symbol: '27' Code: 100000	Prior Symbol: 'y' Symbol: '.' Code: 0111
Prior Symbol: 'r' Symbol: 'v' Code: 110011110	Prior Symbol: 'u' Symbol: 'a' Code: 100111	Prior Symbol: 'y' Symbol: ':' Code: 011001
Prior Symbol: 'r' Symbol: 'w' Code: 01101	Prior Symbol: 'u' Symbol: 'b' Code: 100001	Prior Symbol: 'y' Symbol: '?' Code: 01001110
Prior Symbol: 's' Symbol: '27' Code: 10011100	Prior Symbol: 'u' Symbol: 'c' Code: 10001	Prior Symbol: 'y' Symbol: '@' Code: 0100111
Prior Symbol: 's' Symbol: ':' Code: 0	Prior Symbol: 'u' Symbol: 'd' Code: 11100	Prior Symbol: 'y' Symbol: 'b' Code: 0110000
Prior Symbol: 's' Symbol: '"' Code: 100111100	Prior Symbol: 'u' Symbol: 'e' Code: 11101	Prior Symbol: 'y' Symbol: 'd' Code: 000001
Prior Symbol: 's' Symbol: 'n' Code: 100111101	Prior Symbol: 'u' Symbol: 'g' Code: 11110	Prior Symbol: 'y' Symbol: 'e' Code: 0010
Prior Symbol: 's' Symbol: ';' Code: 111011	Prior Symbol: 'u' Symbol: 'i' Code: 10010	Prior Symbol: 'y' Symbol: 'f' Code: 0110001
Prior Symbol: 's' Symbol: ':' Code: 1000	Prior Symbol: 'u' Symbol: 'k' Code: 1001101	Prior Symbol: 'y' Symbol: 'i' Code: 000010
Prior Symbol: 's' Symbol: '?' Code: 11101011	Prior Symbol: 'u' Symbol: 'l' Code: 0100	Prior Symbol: 'y' Symbol: 'l' Code: 01000
Prior Symbol: 's' Symbol: 'a' Code: 110011	Prior Symbol: 'u' Symbol: 'm' Code: 111111	Prior Symbol: 'y' Symbol: 'm' Code: 000000
Prior Symbol: 's' Symbol: 'b' Code: 100111110	Prior Symbol: 'u' Symbol: 'n' Code: 110	Prior Symbol: 'y' Symbol: 'n' Code: 01011
Prior Symbol: 's' Symbol: 'c' Code: 10010	Prior Symbol: 'u' Symbol: 'o' Code: 11111010	Prior Symbol: 'y' Symbol: 'o' Code: 01101
Prior Symbol: 's' Symbol: 'e' Code: 1101	Prior Symbol: 'u' Symbol: 'p' Code: 0101	Prior Symbol: 'y' Symbol: 's' Code: 0011
Prior Symbol: 's' Symbol: 'h' Code: 11000	Prior Symbol: 'u' Symbol: 'r' Code: 00	Prior Symbol: 'y' Symbol: 'w' Code: 000011
Prior Symbol: 's' Symbol: 'i' Code: 11100	Prior Symbol: 'u' Symbol: 's' Code: 011	Prior Symbol: 'z' Symbol: '27' Code: 100
Prior Symbol: 's' Symbol: 'k' Code: 100111111	Prior Symbol: 'u' Symbol: 't' Code: 101	Prior Symbol: 'z' Symbol: '`' Code: 1110
Prior Symbol: 's' Symbol: 'l' Code: 1110100	Prior Symbol: 'u' Symbol: 'v' Code: 11111011	Prior Symbol: 'z' Symbol: ':' Code: 1111
Prior Symbol: 's' Symbol: 'm' Code: 111010100	Prior Symbol: 'u' Symbol: 'y' Code: 1111100	Prior Symbol: 'z' Symbol: 'a' Code: 000
Prior Symbol: 's' Symbol: 'n' Code: 111010101	Prior Symbol: 'v' Symbol: '27' Code: 00010	Prior Symbol: 'z' Symbol: 'e' Code: 001
Prior Symbol: 's' Symbol: 'o' Code: 11110	Prior Symbol: 'v' Symbol: 'a' Code: 001	Prior Symbol: 'z' Symbol: 'i' Code: 110
Prior Symbol: 's' Symbol: 'p' Code: 1001101	Prior Symbol: 'v' Symbol: 'e' Code: 1	Prior Symbol: 'z' Symbol: 'l' Code: 010
Prior Symbol: 's' Symbol: 'q' Code: 11111	Prior Symbol: 'v' Symbol: 'i' Code: 01	Prior Symbol: 'z' Symbol: 'o' Code: 101
Prior Symbol: 's' Symbol: 'r' Code: 101	Prior Symbol: 'v' Symbol: 'o' Code: 0000	Prior Symbol: 'z' Symbol: 'z' Code: 011
Prior Symbol: 's' Symbol: 'u' Code: 110010	Prior Symbol: 'v' Symbol: 's' Code: 000110	Prior Symbol: '{' Symbol: '27' Code: 1
Prior Symbol: 's' Symbol: 'w' Code: 10011101	Prior Symbol: 'v' Symbol: 'y' Code: 000111	Prior Symbol: ' ' Symbol: '27' Code: 1
Prior Symbol: 's' Symbol: 'y' Code: 1001100	Prior Symbol: 'w' Symbol: '27' Code: 011101	Prior Symbol: '}' Symbol: '27' Code: 1
Prior Symbol: 't' Symbol: '27' Code: 11000011	Prior Symbol: 'w' Symbol: '`' Code: 001	Prior Symbol: '^' Symbol: '27' Code: 1
Prior Symbol: 't' Symbol: '' Code: 111	Prior Symbol: 'w' Symbol: ':' Code: 011100	Prior Symbol: '127' Symbol: '27' Code: 1
Prior Symbol: 't' Symbol: '"' Code: 11000100	Prior Symbol: 'w' Symbol: 'a' Code: 010	
Prior Symbol: 't' Symbol: ':' Code: 0111100	Prior Symbol: 'w' Symbol: 'e' Code: 1110	

Table C7 English-language Program Description Decode Table

0 1	76 1	152 2	228 5	304 155	380 3	456 36
1 0	77 240	153 242	229 208	305 155	381 4	457 37
2 1	78 1	154 2	230 6	306 155	382 5	458 38
3 44	79 242	155 252	231 6	307 155	383 207	459 39
4 1	80 1	156 3	232 6	308 155	384 6	460 40
5 46	81 248	157 8	233 52	309 155	385 201	461 41
6 1	82 1	158 3	234 6	310 155	386 249	462 42
7 48	83 250	159 16	235 96	311 155	387 234	463 244
8 1	84 1	160 3	236 6	312 155	388 235	464 43
9 50	85 252	161 26	237 134	313 155	389 245	465 44
10 1	86 1	162 3	238 6	314 155	390 246	466 45
11 52	87 254	163 40	239 146	315 155	391 7	467 46
12 1	88 2	164 3	240 6	316 155	392 8	468 47
13 54	89 0	165 42	241 170	317 155	393 9	469 225
14 1	90 2	166 3	242 6	318 155	394 178	470 48
15 56	91 4	167 52	243 184	319 155	395 197	471 49
16 1	92 2	168 3	244 6	320 155	396 198	472 50
17 58	93 22	169 74	245 220	321 155	397 177	473 51
18 1	94 2	170 3	246 6	322 155	398 10	474 52
19 60	95 32	171 90	247 236	323 155	399 238	475 53
20 1	96 2	172 3	248 6	324 155	400 203	476 54
21 62	97 34	173 94	249 238	325 155	401 11	477 55
22 1	98 2	174 3	250 6	326 155	402 212	478 155
23 64	99 44	175 100	251 240	327 155	403 12	479 155
24 1	100 2	176 3	252 6	328 155	404 196	480 3
25 66	101 50	177 110	253 242	329 155	405 200	481 4
26 1	102 2	178 3	254 6	330 155	406 210	482 128
27 68	103 56	179 112	255 244	331 155	407 13	483 174
28 1	104 2	180 3	256 20	332 155	408 14	484 200
29 70	105 60	181 114	257 21	333 155	409 15	485 212
30 1	106 2	182 3	258 155	334 155	410 199	486 1
31 72	107 64	183 116	259 214	335 155	411 202	487 2
32 1	108 2	184 3	260 201	336 155	412 206	488 155
33 74	109 68	185 118	261 207	337 155	413 208	489 160
34 1	110 2	186 3	262 215	338 155	414 215	490 155
35 76	111 70	187 120	263 199	339 155	415 16	491 155
36 1	112 2	188 3	264 1	340 155	416 194	492 155
37 78	113 74	189 122	265 162	341 155	417 17	493 155
38 1	114 2	190 3	266 206	342 155	418 204	494 155
39 80	115 76	191 124	267 203	343 155	419 236	495 155
40 1	116 2	192 3	268 2	344 155	420 229	496 155
41 82	117 84	193 126	269 3	345 155	421 231	497 155
42 1	118 2	194 3	270 197	346 155	422 18	498 2
43 84	119 86	195 128	271 204	347 155	423 205	499 243
44 1	120 2	196 3	272 198	348 155	424 19	500 160
45 86	121 88	197 180	273 200	349 155	425 20	501 244
46 1	122 2	198 3	274 4	350 155	426 195	502 155
47 88	123 90	199 206	275 196	351 155	427 21	503 1
48 1	124 2	200 3	276 5	352 155	428 22	504 155
49 90	125 92	201 240	277 194	353 155	429 23	505 155
50 1	126 2	202 4	278 6	354 155	430 237	506 172
51 92	127 94	203 26	279 195	355 155	431 24	507 155
52 1	128 2	204 4	280 210	356 155	432 25	508 155
53 94	129 96	205 88	281 7	357 155	433 242	509 155
54 1	130 2	206 4	282 211	358 155	434 26	510 155
55 96	131 98	207 110	283 8	359 155	435 211	511 155
56 1	132 2	208 4	284 202	360 155	436 27	512 1
57 98	133 118	209 142	285 212	361 155	437 28	513 160
58 1	134 2	210 4	286 9	362 56	438 228	514 155
59 100	135 132	211 172	287 205	363 57	439 29	515 162
60 1	136 2	212 4	288 208	364 173	440 193	516 7
61 102	137 148	213 216	289 10	365 175	441 227	517 8
62 1	138 2	214 4	290 193	366 183	442 30	518 226
63 104	139 162	215 224	291 11	367 218	443 233	519 228
64 1	140 2	216 4	292 12	368 168	444 240	520 229
65 106	141 178	217 244	293 13	369 179	445 226	521 230
66 1	142 2	218 5	294 14	370 181	446 247	522 160
67 222	143 186	219 36	295 15	371 1	447 31	523 242
68 1	144 2	220 5	296 16	372 2	448 243	524 225
69 224	145 200	221 64	297 17	373 155	449 230	525 1
70 1	146 2	222 5	298 18	374 180	450 32	526 2
71 234	147 210	223 118	299 19	375 241	451 33	527 243
72 1	148 2	224 5	300 155	376 162	452 34	528 227
73 236	149 222	225 174	301 155	377 213	453 232	529 3
74 1	150 2	226 5	302 155	378 214	454 239	530 4
75 238	151 234	227 206	303 155	379 217	455 35	531 5

532 155	612 230	692 229	772 2	852 2	932 13	1012 230
533 6	613 245	693 236	773 3	853 3	933 14	1013 237
534 4	614 243	694 155	774 233	854 4	934 15	1014 247
535 128	615 244	695 239	775 4	855 239	935 236	1015 231
536 202	616 155	696 1	776 229	856 5	936 16	1016 246
537 211	617 228	697 242	777 3	857 6	937 244	1017 1
538 162	618 1	698 5	778 155	858 174	938 17	1018 2
539 1	619 237	699 6	779 233	859 1	939 18	1019 155
540 155	620 2	700 245	780 1	860 155	940 242	1020 238
541 2	621 3	701 239	781 225	861 238	941 160	1021 3
542 3	622 4	702 155	782 239	862 233	942 19	1022 4
543 160	623 242	703 236	783 2	863 2	943 20	1023 236
544 155	624 5	704 233	784 3	864 229	944 21	1024 5
545 160	625 6	705 1	785 4	865 155	945 238	1025 245
546 3	626 236	706 225	786 167	866 160	946 22	1026 6
547 4	627 238	707 242	787 238	867 1	947 23	1027 172
548 155	628 7	708 2	788 236	868 3	948 11	1028 228
549 183	629 160	709 229	789 242	869 4	949 12	1029 249
550 244	630 5	710 3	790 243	870 155	950 228	1030 242
551 160	631 6	711 4	791 1	871 232	951 243	1031 7
552 176	632 155	712 3	792 155	872 229	952 155	1032 8
553 243	633 236	713 4	793 2	873 225	953 174	1033 9
554 1	634 245	714 155	794 225	874 239	954 226	1034 174
555 2	635 1	715 229	795 6	875 1	955 1	1035 10
556 185	636 2	716 233	796 155	876 233	956 2	1036 239
557 2	637 225	717 245	797 232	877 2	957 3	1037 11
558 184	638 239	718 225	798 233	878 155	958 236	1038 225
559 155	639 229	719 1	799 1	879 155	959 160	1039 243
560 160	640 233	720 239	800 242	880 155	960 4	1040 12
561 1	641 242	721 2	801 236	881 239	961 233	1041 233
562 174	642 3	722 4	802 2	882 155	962 242	1042 13
563 2	643 4	723 5	803 239	883 155	963 245	1043 14
564 182	644 6	724 160	804 3	884 155	964 5	1044 15
565 155	645 7	725 201	805 229	885 155	965 249	1045 16
566 1	646 155	726 243	806 4	886 155	966 225	1046 229
567 160	647 233	727 155	807 5	887 155	967 6	1047 17
568 160	648 249	728 174	808 155	888 155	968 239	1048 18
569 1	649 242	729 242	809 155	889 155	969 7	1049 160
570 155	650 245	730 1	810 3	890 155	970 229	1050 29
571 176	651 1	731 2	811 4	891 155	971 8	1051 30
572 174	652 2	732 3	812 155	892 155	972 9	1052 169
573 1	653 3	733 238	813 174	893 155	973 10	1053 232
574 155	654 236	734 239	814 1	894 155	974 15	1054 245
575 160	655 239	735 5	815 233	895 155	975 16	1055 155
576 174	656 225	736 155	816 2	896 24	976 241	1056 1
577 1	657 4	737 174	817 225	897 25	977 174	1057 173
578 160	658 232	738 233	818 229	898 232	978 196	1058 187
579 155	659 5	739 229	819 239	899 239	979 249	1059 235
580 155	660 5	740 1	820 9	900 248	980 172	1060 250
581 155	661 6	741 245	821 10	901 155	981 1	1061 2
582 155	662 249	742 2	822 246	902 167	982 227	1062 167
583 1	663 242	743 225	823 249	903 247	983 2	1063 230
584 172	664 245	744 3	824 1	904 250	984 155	1064 226
585 174	665 155	745 4	825 174	905 1	985 242	1065 231
586 155	666 229	746 229	826 227	906 2	986 3	1066 3
587 155	667 239	747 3	827 233	907 3	987 4	1067 4
588 2	668 1	748 225	828 245	908 4	988 160	1068 5
589 3	669 2	749 233	829 155	909 229	989 236	1069 6
590 155	670 233	750 242	830 229	910 174	990 245	1070 233
591 160	671 225	751 155	831 239	911 5	991 5	1071 248
592 181	672 3	752 1	832 2	912 230	992 6	1072 7
593 182	673 4	753 2	833 3	913 226	993 233	1073 172
594 184	674 6	754 3	834 225	914 6	994 7	1074 239
595 1	675 7	755 4	835 4	915 246	995 235	1075 240
596 155	676 225	756 155	836 232	916 235	996 8	1076 8
597 160	677 233	757 233	837 5	917 245	997 244	1077 237
598 155	678 238	758 245	838 6	918 233	998 9	1078 246
599 160	679 246	759 1	839 244	919 7	999 229	1079 249
600 155	680 228	760 229	840 7	920 240	1000 10	1080 9
601 155	681 236	761 2	841 8	921 249	1001 239	1081 247
602 155	682 243	762 239	842 232	922 231	1002 225	1082 10
603 155	683 1	763 225	843 7	923 8	1003 232	1083 11
604 155	684 2	764 225	844 229	924 9	1004 11	1084 174
605 155	685 242	765 5	845 247	925 228	1005 12	1085 12
606 155	686 3	766 155	846 214	926 10	1006 13	1086 227
607 160	687 4	767 227	847 225	927 227	1007 14	1087 13
608 155	688 155	768 239	848 155	928 11	1008 19	1088 229
609 155	689 5	769 1	849 233	929 237	1009 20	1089 244
610 8	690 2	770 245	850 242	930 12	1010 167	1090 14
611 9	691 3	771 229	851 1	931 243	1011 187	1091 15

1092 228	1172 1	1252 167	1332 4	1412 249	1492 246	1572 233
1093 16	1173 2	1253 238	1333 5	1413 233	1493 230	1573 12
1094 236	1174 155	1254 1	1334 233	1414 235	1494 1	1574 239
1095 17	1175 249	1255 172	1335 6	1415 4	1495 155	1575 243
1096 225	1176 245	1256 155	1336 7	1416 227	1496 173	1576 174
1097 18	1177 174	1257 174	1337 8	1417 225	1497 226	1577 13
1098 19	1178 3	1258 2	1338 9	1418 5	1498 240	1578 14
1099 20	1179 238	1259 3	1339 160	1419 246	1499 2	1579 229
1100 21	1180 4	1260 4	1340 225	1420 6	1500 167	1580 15
1101 22	1181 242	1261 243	1341 229	1421 228	1501 3	1581 16
1102 238	1182 5	1262 5	1342 10	1422 7	1502 4	1582 17
1103 243	1183 6	1263 233	1343 11	1423 226	1503 5	1583 244
1104 23	1184 244	1264 6	1344 25	1424 240	1504 245	1584 18
1105 24	1185 7	1265 160	1345 26	1425 8	1505 227	1585 19
1106 242	1186 8	1266 7	1346 173	1426 9	1506 172	1586 20
1107 160	1187 9	1267 229	1347 187	1427 243	1507 231	1587 21
1108 25	1188 239	1268 22	1348 226	1428 244	1508 242	1588 20
1109 26	1189 225	1269 23	1349 234	1429 247	1509 6	1589 21
1110 27	1190 160	1270 167	1350 237	1430 239	1510 235	1590 187
1111 28	1191 10	1271 173	1351 242	1431 10	1511 7	1591 226
1112 9	1192 233	1272 238	1352 250	1432 11	1512 236	1592 173
1113 10	1193 11	1273 227	1353 230	1433 12	1513 237	1593 237
1114 174	1194 12	1274 235	1354 236	1434 13	1514 238	1594 1
1115 155	1195 229	1275 242	1355 1	1435 236	1515 249	1595 155
1116 236	1196 20	1276 155	1356 2	1436 14	1516 8	1596 167
1117 1	1197 21	1277 226	1357 3	1437 15	1517 174	1597 227
1118 245	1198 172	1278 1	1358 155	1438 16	1518 9	1598 172
1119 2	1199 226	1279 2	1359 245	1439 245	1519 10	1599 236
1120 244	1200 248	1280 245	1360 4	1440 237	1520 228	1600 238
1121 230	1201 155	1281 3	1361 167	1441 17	1521 11	1601 2
1122 3	1202 174	1282 244	1362 246	1442 230	1522 12	1602 247
1123 225	1203 250	1283 172	1363 249	1443 160	1523 244	1603 3
1124 229	1204 1	1284 4	1364 5	1444 18	1524 13	1604 4
1125 233	1205 235	1285 5	1365 6	1445 242	1525 243	1605 249
1126 4	1206 2	1286 230	1366 235	1446 19	1526 14	1606 5
1127 242	1207 160	1287 237	1367 239	1447 20	1527 15	1607 6
1128 239	1208 3	1288 246	1368 7	1448 21	1528 16	1608 7
1129 5	1209 4	1289 6	1369 8	1449 238	1529 225	1609 8
1130 6	1210 240	1290 174	1370 9	1450 22	1530 239	1610 244
1131 7	1211 5	1291 240	1371 10	1451 23	1531 17	1611 174
1132 160	1212 6	1292 7	1372 172	1452 24	1532 233	1612 245
1133 8	1213 230	1293 8	1373 11	1453 25	1533 18	1613 9
1134 14	1214 246	1294 243	1374 12	1454 14	1534 19	1614 10
1135 15	1215 7	1295 9	1375 227	1455 15	1535 229	1615 242
1136 173	1216 228	1296 10	1376 174	1456 173	1536 20	1616 225
1137 231	1217 237	1297 228	1377 13	1457 237	1537 160	1617 243
1138 155	1218 231	1298 11	1378 238	1458 249	1538 21	1618 11
1139 167	1219 8	1299 12	1379 233	1459 155	1539 22	1619 12
1140 249	1220 225	1300 249	1380 14	1460 174	1540 23	1620 13
1141 1	1221 239	1301 13	1381 225	1461 1	1541 24	1621 233
1142 236	1222 242	1302 239	1382 15	1462 243	1542 160	1622 14
1143 2	1223 9	1303 14	1383 243	1463 2	1543 22	1623 15
1144 172	1224 10	1304 225	1384 16	1464 3	1544 162	1624 239
1145 242	1225 11	1305 15	1385 17	1465 245	1545 167	1625 229
1146 3	1226 236	1306 16	1386 244	1466 244	1546 226	1626 16
1147 174	1227 12	1307 233	1387 18	1467 240	1547 235	1627 160
1148 243	1228 229	1308 236	1388 231	1468 4	1548 237	1628 232
1149 245	1229 227	1309 17	1389 229	1469 239	1549 238	1629 17
1150 4	1230 13	1310 160	1390 19	1470 5	1550 155	1630 18
1151 5	1231 244	1311 229	1391 20	1471 233	1551 247	1631 19
1152 239	1232 14	1312 18	1392 228	1472 6	1552 1	1632 17
1153 6	1233 243	1313 19	1393 21	1473 232	1553 2	1633 18
1154 7	1234 15	1314 20	1394 22	1474 160	1554 3	1634 239
1155 233	1235 16	1315 21	1395 23	1475 225	1555 187	1635 246
1156 225	1236 17	1316 12	1396 160	1476 236	1556 249	1636 155
1157 8	1237 238	1317 13	1397 24	1477 7	1557 240	1637 235
1158 9	1238 18	1318 167	1398 26	1478 242	1558 4	1638 249
1159 232	1239 19	1319 187	1399 27	1479 8	1559 5	1639 1
1160 10	1240 3	1320 155	1400 194	1480 229	1560 236	1640 160
1161 11	1241 239	1321 1	1401 155	1481 9	1561 6	1641 226
1162 229	1242 155	1322 249	1402 173	1482 10	1562 7	1642 2
1163 12	1243 225	1323 174	1403 172	1483 11	1563 8	1643 225
1164 160	1244 229	1324 226	1404 248	1484 12	1564 245	1644 3
1165 13	1245 245	1325 2	1405 1	1485 13	1565 225	1645 237
1166 13	1246 1	1326 237	1406 174	1486 155	1566 9	1646 4
1167 14	1247 2	1327 243	1407 2	1487 245	1567 172	1647 227
1168 167	1248 8	1328 3	1408 3	1488 25	1568 227	1648 233
1169 172	1249 9	1329 245	1409 229	1489 26	1569 10	1649 5
1170 243	1250 236	1330 239	1410 231	1490 169	1570 232	1650 228
1171 173	1251 249	1331 240	1411 232	1491 187	1571 11	1651 229

1652 231	1671 229	1690 243	1709 172	1728 233	1747 9	1766 233
1653 6	1672 243	1691 238	1710 173	1729 247	1748 10	1767 1
1654 236	1673 249	1692 242	1711 244	1730 167	1749 174	1768 2
1655 240	1674 155	1693 3	1712 233	1731 1	1750 11	1769 3
1656 7	1675 1	1694 229	1713 1	1732 2	1751 12	1770 4
1657 8	1676 239	1695 4	1714 2	1733 187	1752 13	1771 5
1658 9	1677 2	1696 232	1715 225	1734 3	1753 14	1772 155
1659 10	1678 3	1697 160	1716 229	1735 4	1754 15	1773 155
1660 11	1679 225	1698 225	1717 3	1736 236	1755 16	1774 155
1661 243	1680 4	1699 5	1718 155	1737 5	1756 6	1775 155
1662 12	1681 233	1700 239	1719 4	1738 155	1757 7	1776 155
1663 244	1682 10	1701 6	1720 17	1739 238	1758 160	1777 155
1664 238	1683 11	1702 7	1721 160	1740 6	1759 174	1778 155
1665 13	1684 174	1703 8	1722 191	1741 239	1760 225	1779 155
1666 242	1685 155	1704 233	1723 225	1742 7	1761 229	1780 155
1667 14	1686 236	1705 9	1724 226	1743 172	1762 236	1781 155
1668 15	1687 237	1706 5	1725 230	1744 229	1763 250	
1669 16	1688 1	1707 6	1726 237	1745 243	1764 155	
1670 5	1689 2	1708 160	1727 228	1746 8	1765 239	

Annex D: An Overview of PSIP for Terrestrial Broadcast with Application Examples (Informative)

1. INTRODUCTION

The Program and System Information Protocol (PSIP) is a small collection of tables designed to operate within every Transport Stream for terrestrial broadcast of digital TV. Its purpose is to describe the information at the system and event levels for all virtual channels carried in a particular Transport Stream. Additionally, information for analog channels as well as digital channels from other Transport Streams may be incorporated. The relational hierarchy for the component tables is explained through typical application examples in this document.

2. OVERVIEW

Under the adopted ATSC standard for digital TV, the typical 6 MHz channel used for analog TV broadcast supports about 19 Mbps of throughput for terrestrial broadcast. Since audiovisual signals with standard resolution can be compressed using MPEG-2 to sustainable rates of around 6 Mbps, then around 3 or 4 digital TV channels can be safely supported in a single physical channel without congestion. Moreover, enough bandwidth remains within the same Transport Stream to provide several additional low-bandwidth non-conventional services such as: weather reports, stock indices, headline news, software download (for games or enhanced applications), image-driven classified ads, home shopping, pay-per-view information, and others.

It is therefore practical to anticipate that in the future, the list of services (virtual channels) carried in a physical transmission channel (6 MHz of bandwidth for the U.S.) may easily reach ten or more. What is even more important is that the number and type of services may also change continuously, thus becoming a more dynamic medium than what we have today.

An important feature of terrestrial broadcasting is that sources follow a distributed information model rather than a centralized one. Unlike cable or satellite, service providers are geographically distributed and have no interaction with respect to data unification or even synchronization. It is therefore necessary to develop a protocol for describing system information and event descriptions which is followed by every organization in charge of a physical transmission channel. System information allows navigation and access to each of the channels within the Transport Stream, whereas event descriptions give the user content information for browsing and selection.

In this document we describe the development of a transport-based implementation of the PSIP protocol using examples. Our hope is to introduce the reader to the most important concepts and components that constitute the protocol.

3. ELEMENTS OF PSIP

PSIP is a collection of hierarchically-associated tables each of which describes particular elements of typical digital TV services. Figures D1 and D2 show the different components and the notation used to describe them. The packets of the base tables are all labeled with the base PID (base_PID) which has been chosen as 0x1FFB. The base tables are: the System Time Table

(STT), the Rating Region Table (RRT), the Master Guide Table (MGT), and the Virtual Channel Table (VCT).

A second set of tables are the Event Information Tables (EIT) whose packet identifiers (PIDs) are defined in the MGT. A third set of tables are the Extended Text Tables (ETT), and similarly, their packet identifiers (PIDs) are defined in the MGT.

The System Time Table (STT) is a small data structure that fits in one Transport Stream packet and serves as a reference for time of day. Receivers can use this table as a reference for timing start times of advertised events.

It should be noted that, except for the MGT, PSIP table sections may start in any byte position within an MPEG-2 transport stream packet. The Master Guide Table is special in that the first byte always is aligned with the first byte of the packet payload. The A/65 standard states this restriction as the `pointer_field` of the Transport Stream packet carrying the `table_id` field of the MGT section shall have the value 0x00 (section starts immediately after the `pointer_field`).

In general, table sections may span packet boundaries. Also, if the table sections are small enough, more than one PSIP table section may be present within a single transport stream packet. The MPEG-2 `pointer_field` mechanism is used to indicate the first byte of a table section within a packet payload. The starting byte of subsequent table sections that might be in the same payload is determined by processing successive `section_length` fields. The location of the `section_length` field is guaranteed to be consistent for any type of PSIP table section, as the format conforms to MPEG-2 defined Program Specific Information (PSI) tables.

If a packet payload does not include the start of a table section, the `payload_unit_start_indicator` bit in the packet header is set to '0' and the `pointer_field` is not present.

Transmission syntax for the United States' voluntary program rating system is included in this standard. When required, the Rating Region Table (RRT) has been designed to transmit the rating standard in use for each country using the standard. Provisions were made for different rating systems for different regions and multi-country regions as well.

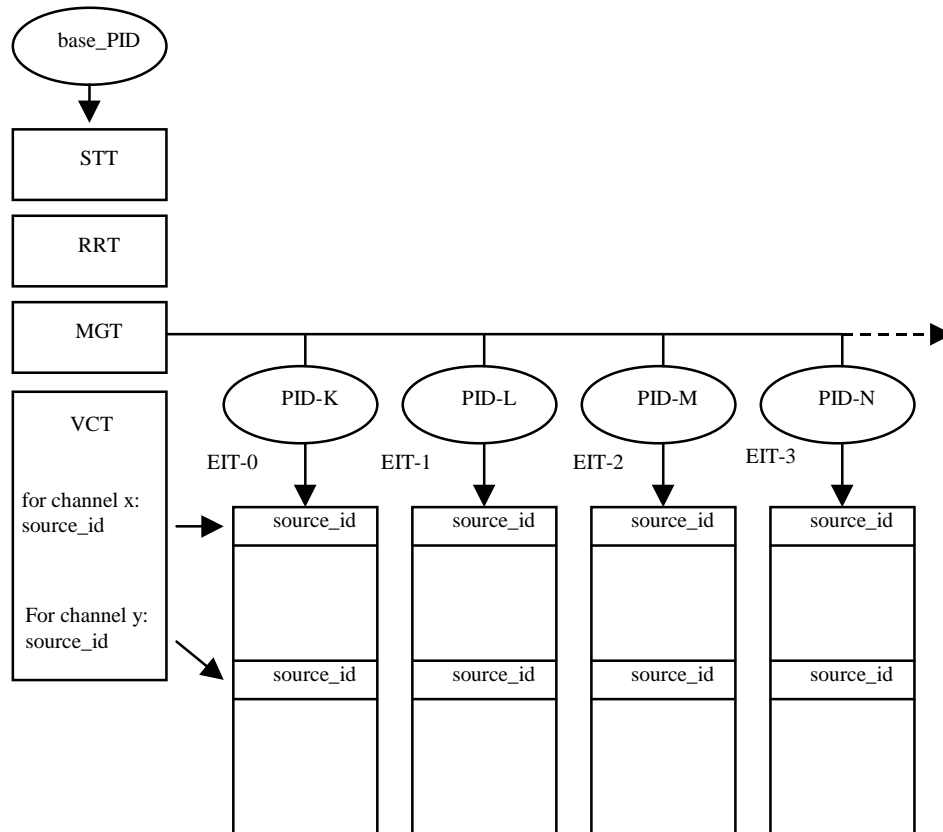

Figure D1 Main Structure for the PSIP tables.

The Master Guide Table (MGT) provides general information about all of the other tables that comprise the PSIP standard. It defines table sizes necessary for memory allocation during decoding; it defines version numbers to identify those tables that need to be updated; it has a constrained header location to facilitate receiver acquisition; and it gives the packet identifiers (PIDs) that label the tables.

The Virtual Channel Table (VCT), also referred to as the Terrestrial VCT (TVCT), contains a list of all the channels that are or will be on-line plus their attributes. Among the attributes we have the channel name, navigation identifiers, stream components and types, etc.

As part of PSIP there are several Event Information Tables, each of which describes the events or TV programs associated with each of the virtual channels listed in the VCT. Each EIT is valid for a time interval of 3 hours. Since the total number of EITs is 128, up to 16 days of programming may be advertised in advance. EIT-0 always denotes the current 3 hours of programming, EIT-1 the next 3 hours, and so on. As a minimum, the first four EITs must always be present in every Transport Stream.

Start times for EITs are constrained to be one of the following UTC times: 0:00 (midnight), 3:00, 6:00, 9:00, 12:00 (noon), 15:00, 18:00, and 21:00. Imposing constraints on the start times as well as the interval duration is necessary for the purpose of re-multiplexing. During re-multiplexing, EIT tables coming from several distinct Transport Streams may end up grouped

together or *vice versa*. If no constraints were imposed, re-multiplexing equipment would have to parse EITs by content in real time, which is a difficult task.

For example, consider a broadcast corporation operating in the Eastern time zone of the U.S. This corporation decides to carry 6 EITs (18 hours of TV program information). If at present, the Eastern time is 15:30 EDT (19:30 UTC), then the coverage times for the EIT tables are:

Table D1 An Example of EIT Coverage Times

EIT number	Version Num.	Assigned PID	Coverage (UTC)	Coverage (EDT)
0	6	123	18:00 - 21:00	14:00 - 17:00
1	4	190	21:00 - 24:00	17:00 - 20:00
2	2	237	0:00 - 3:00	20:00 - 23:00
3	7	177	3:00 - 6:00	23:00 - 2:00 (nd)
4	8	295	6:00 - 9:00	2:00 (nd) - 5:00 (nd)
5	15	221	9:00 - 12:00	5:00 (nd) - 8:00 (nd)

The abbreviation “nd” denotes next day. Before 17:00 EDT, the MGT will list the currently valid PIDs as: 123, 190, 237, 177, 295, and 221. At 17:00 EDT, table EIT-0 will become obsolete while the other ones will remain valid. At that time, the PID list can be changed to 190, 237, 177, 295, 221, maintaining the version number list as 4, 2, 7, 8, 15. Therefore, by simply shifting the listed PID values in the MGT, table EIT-1 can become EIT-0, table EIT-2 can become EIT-1, and so on.

However, it is also possible to regenerate one or several EITs at any time for correcting and/or updating the content (e.g., in cases where “to be assigned” events become known). Regeneration of EITs is flagged by updating version fields in the MGT. For example, if table EIT-2 needs to be updated at 16:17 EDT, then the new table must be transmitted with a version number equal to 3. Whenever the decoder monitoring the MGT detects a change in the version number of a table, it assumes that the table has changed and needs to be reloaded.

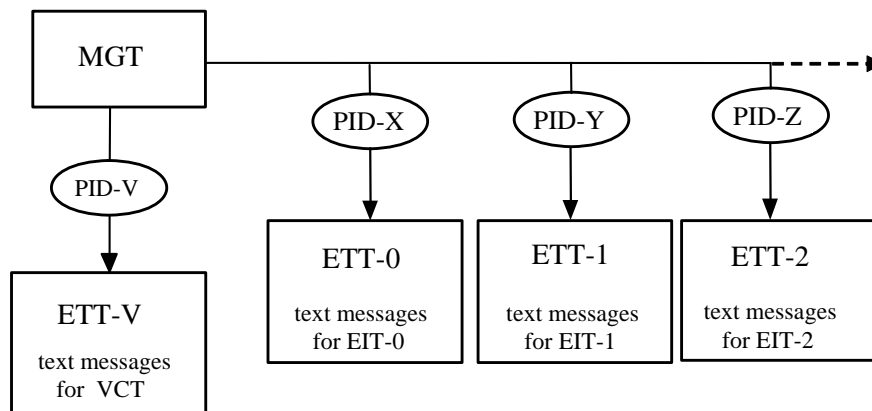

Figure D2 Extended Text Tables in the PSIP hierarchy.

As illustrated in Figure D2, there can be several Extended Text Tables (ETTs), each of them having its PID defined in the MGT. Each Event Information Table (EIT) can have one ETT. Similarly, the Virtual Channel Table can have one ETT. As its name indicates, the purpose of an Extended Text Table (ETT) is to carry text messages. For example, for channels in the VCT, the messages can describe channel information, cost, coming attractions, etc. Similarly, for an event such as a movie listed in the EIT, the typical message is a short paragraph that describes the movie itself. Extended Text Tables are optional.

In this final section paragraph we review once more the requirement list. The minimum amount of information required in an ATSC terrestrial digital Transport Stream is the VCT, the MGT, the RRT, the STT, and the first four EITs. All of the other elements are optional.

4. APPLICATION EXAMPLE

For the purpose of this example, we assume that a broadcast group, here denominated NBZ, manages the frequency bands for RF channels 12 and 39. The first one is its analog channel whereas the second one will be used for digital broadcast. According to the premises established in this document, NBZ must carry the PSIP tables in the digital Transport Stream of RF channel 39. The tables must describe TV programs and other services provided on RF channel 39 but can also describe information for the analog RF channel 12.

Assume that NBZ operates in the Eastern time zone of the U.S., and that the current time is 15:30 EDT (19:30 UTC). NBZ decides to operate in minimal configuration, therefore only the first four EITs need to be transmitted. As explained previously, EIT-0 must carry event information for the time window between 14:00 and 17:00 EDT, whereas EIT-1 to EIT-3 will cover the subsequent 9 hours. For the first 6 hours, the following scenario applies:

Table D2 The First 3-Hour Segment to be Described in VCT and EIT-0

		14:00-14:30	14:30 -15:00	15:00 - 15:30	15:30 - 16:00	16:00 - 16:30	16:30-17:00
PTC 12 (12-0)	NBZ	City Life	City Life	Travel Show	Travel Show	News	News
PTC 39 (12-1)	NBZ	City Life	City Life	Travel Show	Travel Show	News	News
PTC 39 (12-2)	NBZ	Soccer	Golf Report	Golf Report	Car Racing	Car Racing	Car Racing
PTC 39 (12-3)	NBZ	Secret Agent	Secret Agent	Lost Worlds	Lost Worlds	Lost Worlds	Lost Worlds
PTC 39 (12-4)	NBZ	Headlines	Headlines	Headlines	Headlines	Headlines	Headlines

Table D3 The Second 3-Hour Segment to be Described in VCT and EIT-1

		17:00-17:30	17:30-18:00	18:00 - 18:30	18:30 - 19:00	19:00-19:30	19:30 - 20:00
PTC 12 (12-0)	NBZ	Music Today	NY Comedy	World View	World View	News	News
PTC 39 (12-1)	NBZ	Music Today	NY Comedy	World View	World View	News	News
PTC 39 (12-2)	NBZ	Car Racing	Car Racing	Sports News	Tennis Playoffs	Tennis Playoffs	Tennis Playoffs
PTC 39 (12-3)	NBZ	Preview	The Bandit	The Bandit	The Bandit	The Bandit	Preview
PTC 39 (12-4)	NBZ	Headlines	Headlines	Headlines	Headlines	Headlines	Headlines

Similar tables can be built for the next 6 hours (for EIT-2 and EIT-3). According to this scenario, NBZ broadcasts four regular digital channels (also called virtual channels and denoted by their major and minor channel numbers), one with the same program as the analog transmission, another for sports, and a third one for movies. The fourth one supports a service displaying headlines with text and images.

4.1 The Master Guide Table (MGT)

The purpose of the MGT is to describe everything about the other tables, listing features such as version numbers, table sizes, and packet identifiers (PIDs). Figure D3 shows a typical Master Guide Table indicating, in this case, the existence in the Transport Stream of a Virtual Channel Table, the Rating Region Table, four EITs, one Extended Text Table for channels, and two Extended Text Tables for events.

The first entry of the MGT describes the version number and size of the Virtual Channel Table. The second entry corresponds to an instance of the Rating Region Table. If some region's policy makers decided to use more than one instance of an RRT, the MGT would list each PID, version number, and size. Notice that the base PID (0x1FFB) must be used for the VCT and the RRT instances as specified in PSIP.

The next entries in the MGT correspond to the first four EITs that must be supplied in the Transport Stream. The user is free to choose their PIDs as long as they are unique in the MGT list of PIDs. After the EITs, the MGT indicates the existence of an Extended Text Table for channels carried using PID 0x1AA0. Similarly, the last two entries in the MGT signal the existence of two Extended Text Tables, one for EIT-0 and the other for EIT-1.

MGT			
table_type	PID	version_num.	table size
VCT	0x1FFB (base_PID)	4	485 bytes
RRT	0x1FFB (base_PID)	1	560 bytes
EIT-0	0x1FD0	6	2730 bytes
EIT-1	0x1FD1	4	1342 bytes
EIT-2	0x1DD1	2	1224 bytes
EIT-3	0x1DB3	7	1382 bytes
ETT for VCT	0x1AA0	21	4232 bytes
ETT-0	0x1BA0	10	32420 bytes
ETT-1	0x1BA1	2	42734 bytes

Figure D3 Content of the Master Guide Table.

Descriptors can be added for each entry as well as for the entire MGT. By using descriptors, future improvements can be incorporated without modifying the basic structure of the MGT. The MGT is like a flag table that continuously informs the decoder about the status of all the other tables (except the STT which has an independent function). The MGT is continuously monitored at the receiver to prepare and anticipate changes in the channel/event structure. When tables are changed at the broadcast side, their version numbers are incremented and the new numbers are listed in the MGT. Based on the version updates and on the memory requirements, the decoder can reload the newly defined tables for proper operation.

4.2 The Virtual Channel Table (VCT)

Figure D4 shows the structure of the VCT which essentially contains the list of channels available in the Transport Stream. For convenience, it is possible to include analog channels and even other digital channels found in different Transport Streams.

The field `number_of_channels_in_section` indicates the number of channels described in one section of the VCT. In normal applications, as in the example being considered here, all channel information will fit into one section. However, there may be rare times when most of the physical channel is used to convey dozens of low-bandwidth services such as audio-only and data channels in addition to one video program. In those cases, the channel information may be larger than the VCT section limit of 1 Kbyte and therefore VCT segmentation will be required.

For example, assuming that a physical channel conveys 20 low-bandwidth services in addition to a TV program, and assuming that their VCT information exceeds 1 Kbyte, then two or more sections may be defined. The first section may describe 12 virtual channels and the second 9 if such a partition leads to VCT sections with less than 1 Kbyte.

A new VCT containing updated information can be transmitted at any time with the `version_number` increased by one. However, since a VCT describes only those channels from a particular Transport Stream, virtual channels added to the VCT at arbitrary times will not be detected by the receiver until it is tuned to that particular Transport Stream. For this reason, it is highly recommended that channel addition be made in advance to give the receivers the opportunity to scan the frequencies and detect the channel presence.

The fields `major_channel_number` and `minor_channel_number` are used for identification. The first one, the major channel number, is used to group all channels that are to be identified as belonging to a particular broadcast corporation (or particular identifying number such as 12 in this case). The minor channel number specifies a particular channel within the group.

The field `short_name` is a seven-character name for the channel and may allow text-based access and navigation. The fields `transport_stream_id` and `program_number` are included to link the VCT with the PAT and sections of the PMT. A sequence of flags follows these fields. The flags indicate: 1) if the channel is hidden (e.g., for NVOD applications), 2) if the channel has a long text message in the VCT-ETT, and 3) if the channel is visible in general or has some conditional access constraints.

After the flags, a description of the type of service offered is included, followed by the `source_id`. The `source_id` is simply an internal index for representing the particular logical channel. Event Information Tables and Extended Text Tables use this number to provide a list of associated events or text messages respectively.

VCT									
current_next_indicator = 1 number_channels_in_section = 5									
major num.	minor num.	short name	channel TSID	progr. num.	flags	service type	source id	descriptors	
12	0	NBZ	0x0AA0	0xFFFF	--	analog	20	ch_name	
12	1	NBZD	0x0AA1	0x00F1	--	digital	21	ch_name serv_locat.	
12	5	NBZ-S	0x0AA1	0x00F2	--	digital	2	ch_name serv_locat.	
12	12	NBZ-M	0x0AA1	0x00F3	--	digital	23	ch_name serv_locat.	
12	31	NBZ-H	0x0AA1	0x00F8	--	digital	24	ch_name serv_locat.	

Figure D4 Content of the Virtual Channel Table.

Two descriptors are associated with the logical channels in the example. The first one is `extended_channel_name` and, as its name indicates, it gives the full name of the channel. An example for channel NBZ-S could be: “NBZ Sports and Fitness”. The other one, the `service_location` descriptor, is used to list the available bit streams and their PIDs necessary to decode packets at the receiver. Assuming that NBZ-M offers bilingual transmission, then the following attributes are tabulated within its `service_location` descriptor:

PID_audio_1	AC-3 audio	English
PID_audio_2	AC-3 audio	Spanish
PID_video	MPEG-2 video	No lang.

Two VCTs may exist simultaneously in a Transport Stream: the current and the next VCT. The current VCT is recognized by having the flag `current_next_indicator` set to 1, while the next one has this flag set to 0. The “next” VCT should not be transmitted when it fits into a single table section, since delivery of the new “current” table will take effect as soon as the one (and only) section arrives. Multi-sectioned next VCTs may be sent, but should not be delivered until immediately before the point at which they are to become current. This recommendation arises because no mechanism is available to update the “next” tables without affecting the current table definition.

For multi-sectioned VCTs, delivery of the “next” table is helpful. Consider a Transport Stream containing the following table sections:

- Current VCT, version_number=5, section 1 of 2
- Current VCT, version_number=5, section 2 of 2
- Next VCT, version_number=6, section 1 of 2
- Next VCT, version_number=6, section 2 of 2

At the point in time when the “next” tables are to become current, the following table section may be placed into the Transport Stream:

- Current VCT, version_number=6, section 1 of 2

At the moment this table section is processed, both sections of the version 6 VCT are understood to be the new “current” VCT, even before section 2 of 2 of VCT version 6 labeled “current” is received. As long as the “next” table sections have been cached, they can be taken as “current” as soon as the version number is seen to increment.

When the VCT refers to an analog service type, the channel_TSID cannot refer to the identifier of a "Transport Stream" in the MPEG-2 sense. Analog NTSC broadcast signals can, however, carry a 16-bit unique identifier called a "Transmission Signal Identifier."¹⁹ For the example VCT in Figure D4, the Transmission Signal Identifier for channel 12.0 is 0x0AA0. Subsequently, receivers are expected to associate the NTSC broadcast identified by the Transmission Signal ID with the frequency tuned to acquire it. Given this association, a receiver can use the Transmission Signal ID to determine how to tune to the NTSC channel it identifies.

It is recommended that the broadcaster insert into the VCT any major-minor channel that would be used to carry any program announced in the EIT. This means if no current program was using 7-7, and if a program 16 days from now was going to use 7-7, that 7-7 would be in the VCT. This would enable receivers to include the channel number in a program guide presented to the consumer. If a program is announced in the EIT and the source ID for that program is not found in the VCT, the receiver cannot determine which "channel" to display for that program.

Any channels in the VCT which are not currently active shall have the hidden attribute set to 1 and the hide_guide attribute set to 0.

The following table shows DTV behavior for the various combinations of the hidden and hide_guide attributes. In the table the “x” entry indicates “don’t care.” A check in the “surf” column indicates the channel is available by channel surfing and via direct channel number entry. A check in the “guide” column indicates that the channel may appear in the program guide listing.

Table D4 Receiver Behavior with Hidden and Hide Guide Attributes

hidden	hide_guide	Receiver Behavior		Description
		Surf	Guide	
0	x	✓	✓	Normal channel
1	1			Special access only
1	0		✓	Inactive channel

¹⁹ The 16-bit “Transmission Signal ID” for the NTSC VBI is specified in CEA-608-B [3] Section 9.5.2.4.

4.3 The Event Information Tables (EITs)

The purpose of an EIT is to list all events for those channels that appear in the VCT for a given time window. As mentioned before, EIT-0 describes the events for the first 3 hours, EIT-1 for the next 3 hours, and so on. EIT-i and EIT-j have different PIDs as defined in the MGT. In PSIP, tables can have a multitude of instances. The different instances of a table share the same `table_id` value and PID but use different `table_id_extension` values.

In PSIP, an instance of EIT-k contains the list of events for a single virtual channel with a unique `source_id`. For this reason, the `table_id_extension` has been renamed as `source_id` in the EIT syntax. Figure D5 shows, for example, the NBZ-S instance for EIT-0. Following similar procedures, the NBZD, NBZ-M, and NBZ-H instances of EIT-0 can be constructed. The process can be extended and repeated to obtain all of the instances for the other tables in the time sequence: EIT-1, EIT-2, etc.

The three events programmed for the 3-hour period for NBZ-S are listed in Figure D5. The field `event_id` is a number used to identify each event. If an event time period extends over more than one EIT, the same `event_id` has to be used. The `event_id` is used to link events with their messages defined in the ETT, and therefore it has to be unique only within a virtual channel and a 3-hour interval defined by EITs. The `event_id` is followed by the `start_time` and then the `length_in_seconds`. Notice that events can have start times before the activation time (14:00 EDT in this example) of the table. The `ETM_location` specifies the existence and the location of an Extended Text Message (ETM) for this event. ETMs are simply long textual descriptions. The collection of ETMs constitutes an Extended Text Table (ETT).

EIT-0					
source_id = 22 (NBZ-S instance)					
num_events_in_section = 3					
event ID	local start time	Length (seconds)	ETM location	title	descriptors
51	12:30	7200	01	Soccer Live	content_advisory
52	14:30	3600	00	Golf Report	closed_caption
53	15:30	9000	01	Car Racing	content_advisory

Figure D5 Content of EIT-0 for NBZ-S

An example of an ETM for the Car Racing event may be:

“Live coverage from Indianapolis. This car race has become the largest single-day sporting event in the world. Two hundred laps of full action and speed.”

Several descriptors can be associated with each event. One is the content advisory descriptor which assigns a rating value according to one or more systems. Recall that the actual rating system definitions are tabulated within the RRT. Another is a closed caption descriptor which signals the existence of closed captioning and lists the necessary parameters for decoding.

4.4 The Rating Region Table (RRT)

The Rating Region Table is a fixed data structure in the sense that its content remains mostly unchanged. It defines the rating standard that is applicable for each region and/or country. The concept of table instance introduced in the previous Section is also used for the RRT. Several instances of the RRT can be constructed and carried in the Transport Stream simultaneously. Each instance is identified by a different `table_id_extension` value (which becomes the `rating_region` in the RRT syntax) and corresponds to one and only one particular region. Each instance has a different version number which is also carried in the MGT. This feature allows updating each instance separately.

Figure D6 shows an example of one instance of an RRT, for a region called “Tumbolia,” assigned by the ATSC to `rating_region` 20. Each event listed in any of the EITs may carry a content advisory descriptor. This descriptor is an index or pointer to one or more instances of the RRT.

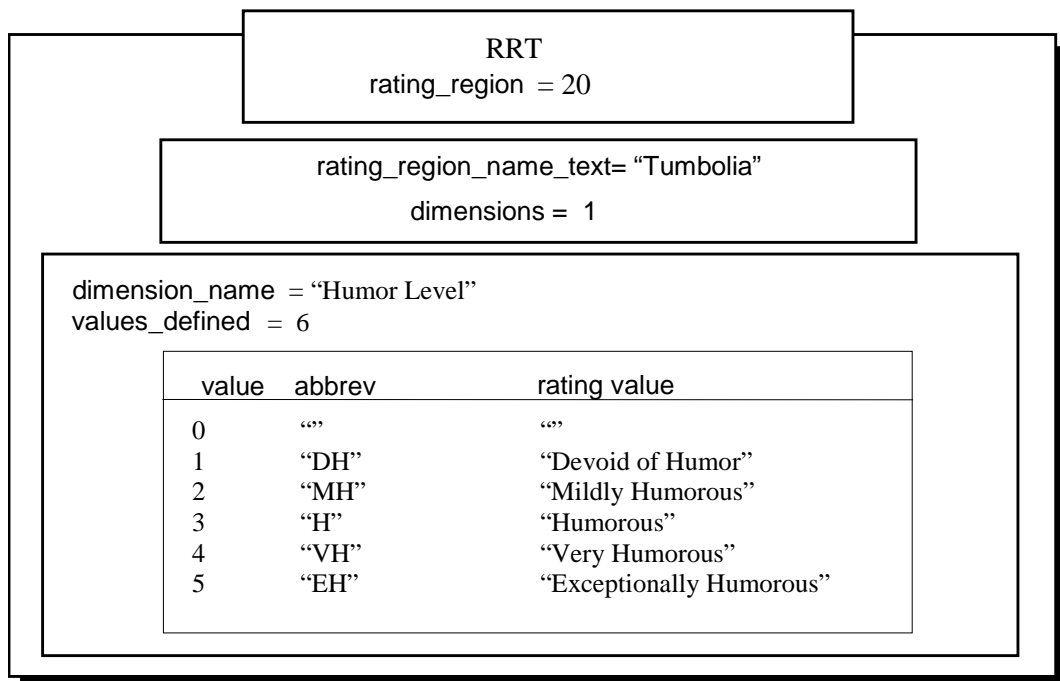

Figure D6 An Instance of a Rating Region Table (RRT).

5. PACKETIZATION AND TRANSPORT

In the previous sections, we have described how to construct the MGT, VCT, RRT, and EITs based on the typical scenario described in Tables D1 and D2. The number of virtual channels described in the VCT is 5 and therefore, each EIT will have 5 instances.

For the example, the size of the MGT is less than a hundred bytes and the VCT ranges between 300 to around 1500 bytes depending on the length of the text strings. Similarly, each EIT instance can have from 1 to about 3 Kbytes depending again on the text length.

Typically, the MGT, STT, VCT, and each instance of the RRT and EIT will have one or at most a few sections. For each table, the sections are appended one after the other, and then segmented into 184-byte packets. After adding the 4-byte MPEG-2 TS header, the packets are multiplexed with the others carrying audio, video, data, and any other components of the service. Figure D7 illustrates this process.

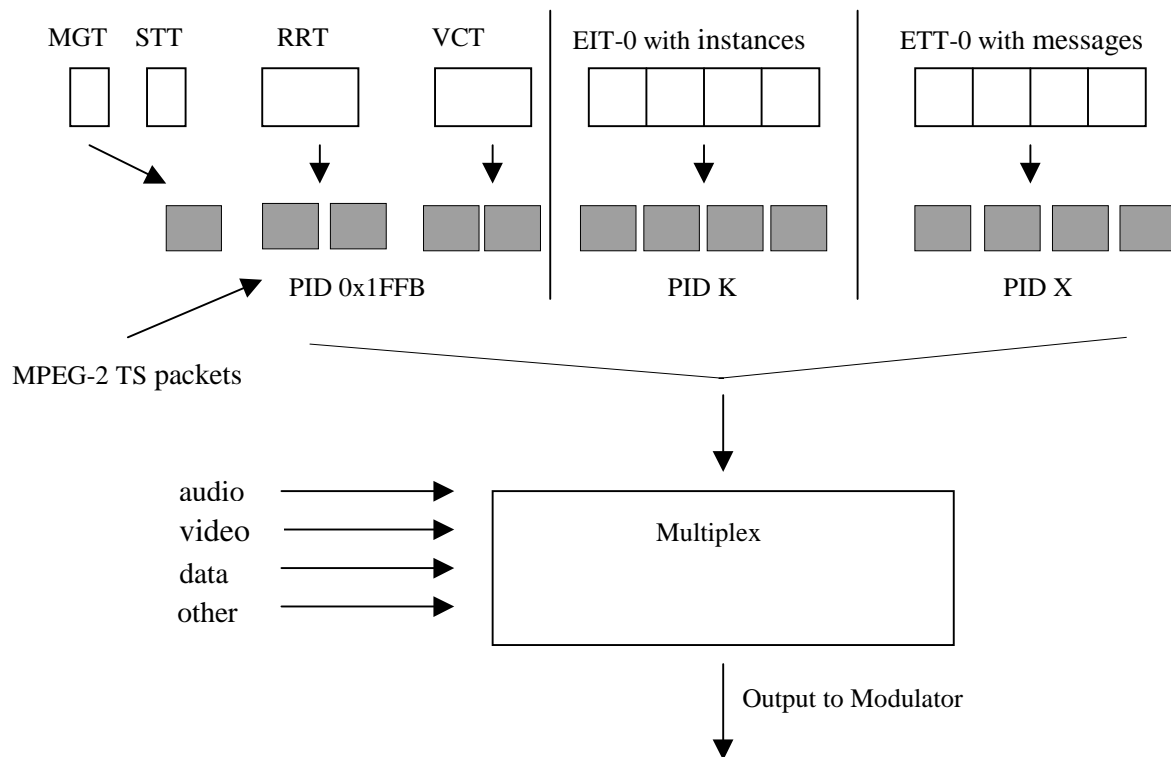

Figure D7 Packetization and Transport of the PSIP tables.

6. TUNING OPERATIONS AND TABLE ACCESS

As described by the PSIP protocol, each Transport Stream will carry a set of tables describing system information and event description. For channel tuning, the first step is to collect the VCT from the Transport Stream which contains the current list of services available. Figure D8 shows this process.

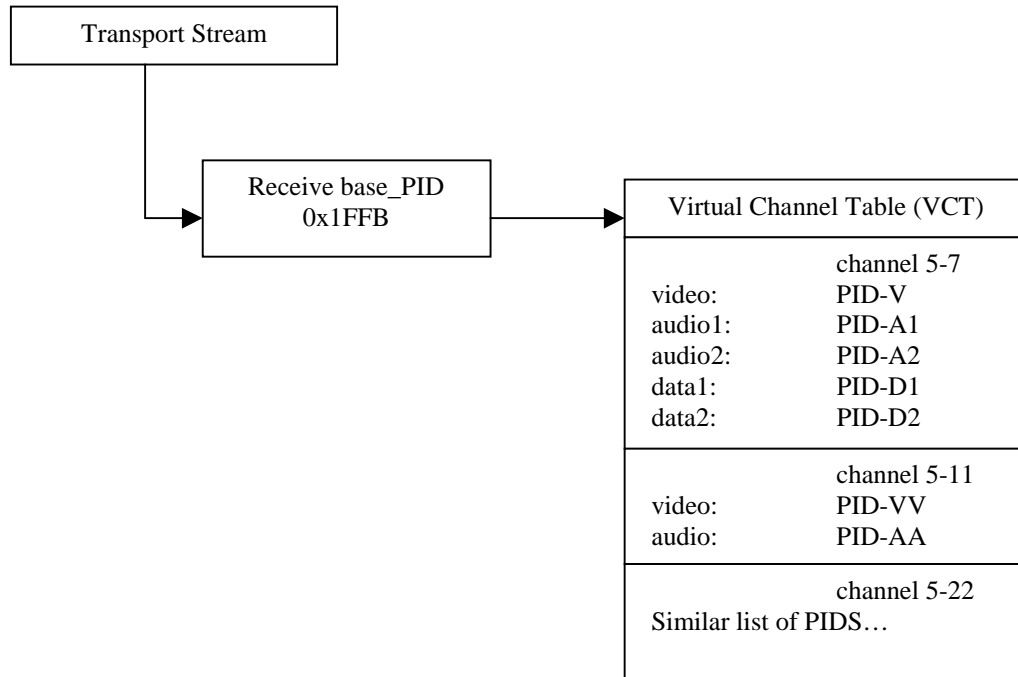

Figure D8 Extraction of the VCT from the Transport Stream.

Once the VCT has been collected, a user can tune to any virtual channel present in the Transport Stream by referring to the major and minor channel numbers. Assuming that in this case, the user selects channel 5 - 11, then the process for decoding the audio and video components is shown in Figure D9.

For terrestrial broadcast, the existence of a service location descriptor in the TVCT is mandatory. The PID values needed for acquisition of audio and video elementary streams may be found in either a `service_location_descriptor()` within a TVCT, or in a `TS_program_map_section()`. The `service_location_descriptor()` has been included in PSIP to minimize the time required for changing and tuning to channels. However, PAT and PMT information is required to be present in the Transport Stream to provide MPEG-2 compliance. Access to data or other supplemental services may require access to the PAT or `TS_program_map_section()`. Cable systems may or may not carry the Service Location Descriptor, and the information contained therein will be found in the `TS_program_map_section()`.

The PMT should always be processed and monitored for changes because, in some instances, the structure of a service may exceed the capability of the `service_location_descriptor()` to describe it. One example is a service that includes multiple audio tracks for the same language (see Section 6.9.8). In this case, the `TS_program_map_section()` carries the textual name for each of the tracks to help in user selection.

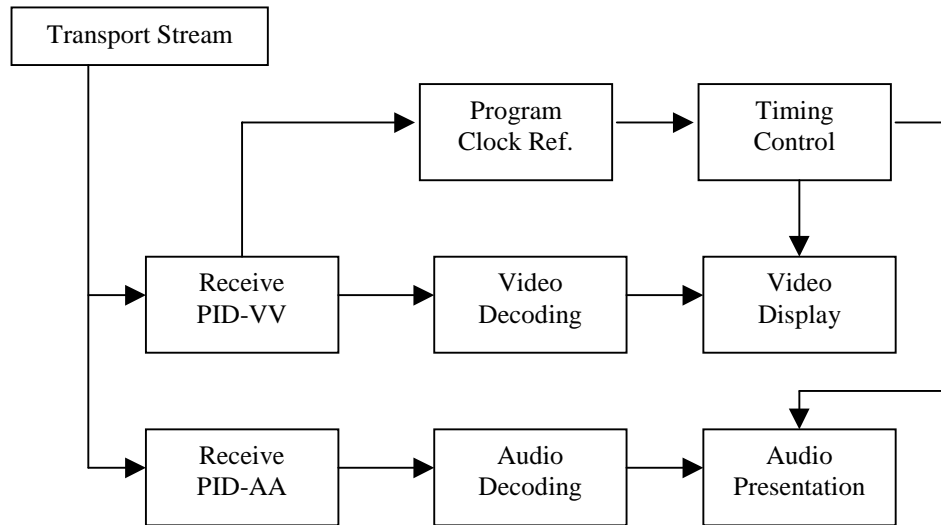

Figure D9 Acquisition of audiovisual components.

7. GPS TIME

The System Time Table provides time of day information to receivers. In PSIP, time of day is represented as the number of seconds that have elapsed since the beginning of “GPS time,” 00:00:00 UTC January 6th, 1980. GPS time is referenced to the Master Clock at the US Naval Observatory and steered to Coordinated Universal Time (UTC). UTC is the time source we use to set our clocks.

UTC is occasionally adjusted by one-second increments to ensure that the difference between a uniform time scale defined by atomic clocks does not differ from the Earth's rotational time by more than 0.9 seconds. The timing of occurrence of these “leap seconds” is determined by careful observations of the Earth’s rotation; each is announced months in advance. On the days it is scheduled to occur, the leap second is inserted just following 12:59:59 PM UTC.

UTC can be directly computed from the count of GPS seconds since January 6, 1980, by subtracting from it the count of leap seconds that have occurred since the beginning of GPS time. In the months just following January 1, 1999, this offset was 13 seconds.

In the A/65 protocol, times of future events (such as event start times in the EIT) are specified the same as time of day, as the count of seconds since January 6, 1980. Converting an event start time to UTC and local time involves the same calculation as the conversion of system time to local time. In both cases, the leap seconds count is subtracted from the count of GPS seconds to derive UTC.

GPS time is used to represent future times because it allows the receiver to compute the time interval to the future event without regard for the possible leap second that may occur in the meantime. Also, if UTC were to be used instead, it wouldn’t be possible to specify an event time that occurred right at the point in time where a leap second was added. UTC is discontinuous at those points.

Around the time a leap second event occurs, program start times represented in local time (UTC adjusted by local time zone and [as needed] daylight savings time) may appear to be off

by plus or minus one second. PSIP generating equipment may use one of two methods to handle leap seconds.

In method A, PSIP generating equipment does not anticipate the future occurrence of a leap second. In this case, prior to the leap second, program start times will appear correct. An event starting at exactly 10 AM will be computed as starting at 10:00:00. But just following the leap second, that same event time will be computed as 9:59:59. The PSIP generating equipment should re-compute the start times in all the EITs and introduce the leap second correction. Once that happens, and receivers have updated their EIT data, the computed time will again show as 10:00:00. In this way the disruption can be limited to a matter of seconds.

In method B, PSIP generating equipment does anticipate the occurrence of a leap second, and adjusts program start times for events happening after the new leap second is added. If the leap second event is to occur at midnight tonight, an event starting at 10 AM tomorrow will be computed by receiving equipment as starting at 10:00:01.

For certain types of events, the precision of method B is necessary. By specifying events using a time system that involves no discontinuities, difficulties involving leap seconds are avoided. Events such as program start times do not require that level of precision. Therefore, method A works well.

Consider the following example. Times are given relative to UTC, and would be corrected to local time zone and daylight savings time as necessary.

- Time of day (UTC): 1:00 p.m., December 30, 1998
- Event start time (UTC): 2:00 p.m., January 2, 1999
- A leap second event will occur just after 12:59:59 p.m. on December 31, 1998
- Leap seconds count on December 30 is 12

The data in the System Time message is:

- GPS seconds = 599,058,012 = 0x23B4E65C
- GPS to UTC offset = 12

Using method A (upcoming leap second event is not accounted for):

- Event start time in EIT: 599,320,812 = 0x23B8E8EC
- Converted to UTC: 2:00:00 p.m., January 2, 1999
- Number of seconds to event: 262,800 = 73 hours, 0 minutes, 0 seconds

Using method B (upcoming leap second event is anticipated):

- Event start time in EIT: 599,320,813 = 0x23B8E8ED
- Converted to UTC: 2:00:01 p.m., January 2, 1999
- Number of seconds to event: 262,801 = 73 hours, 0 minutes, 1 second

Note that using method B, the number of seconds to event is correct, and does not need to be recomputed when the leap seconds count moves from 12 to 13 at year-end.

8. NVOD EXAMPLES

The examples within this annex describe an NVOD Base channel with four Child channels. (See Figures D10 and D11.) The most delayed Child channel runs four hours after its Base channel.

Five channel NVOD system.

The base channel, which contains the time_shifted_service_descriptor() has six two-hour events per day. The child channels are delayed by one, two, three, and four hours respectively.

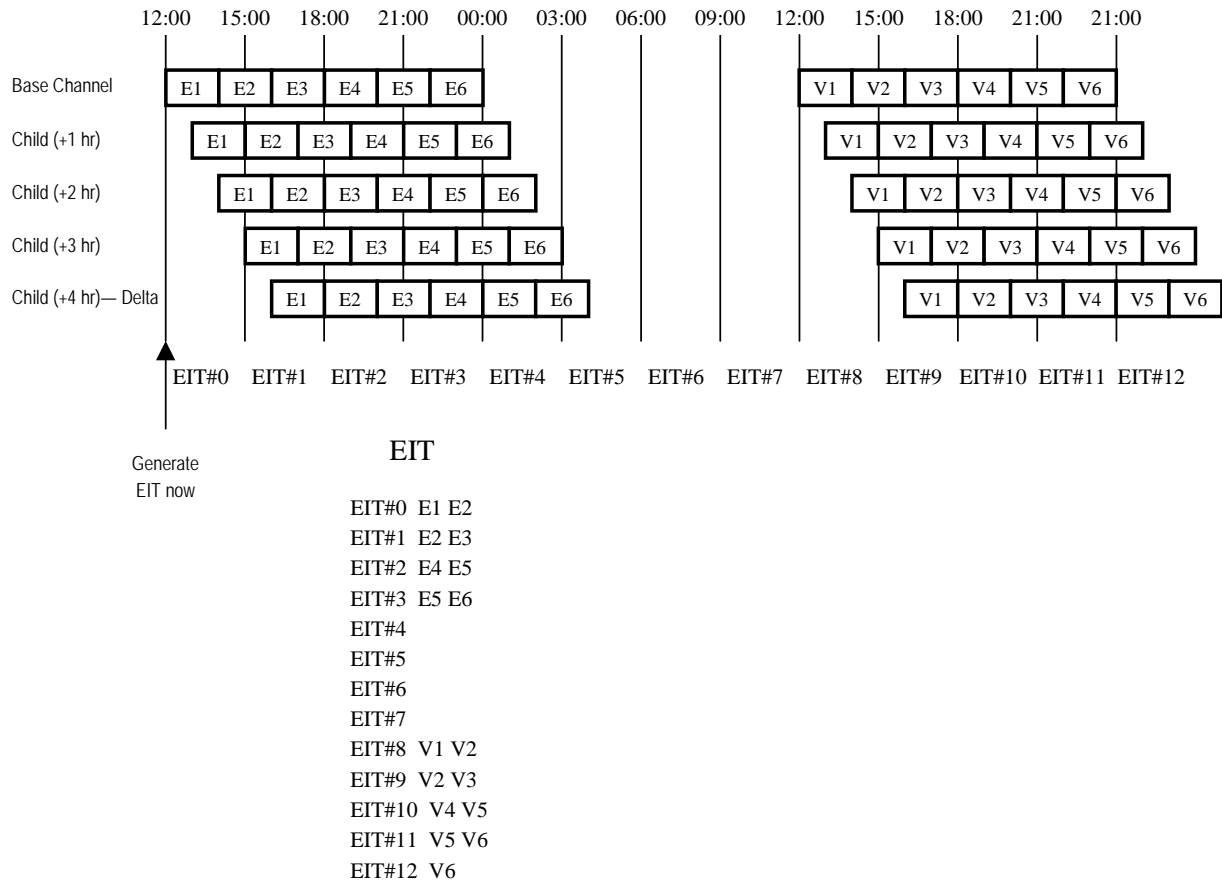

Figure D10 NVOD Example no. one.

Notes:

As there are no events that have expired in the base channel, all EIT and ETT entries are the same as those for an ordinary channel.

To find what event starts on channel Delta at 18:00 the steps are:

- 11) Subtract the channel’s time offset (4 hours) from 18:00, giving 14:00.
- 12) Calculate which EIT window covers 14:00, giving EIT#0.
- 13) Look in EIT#0 of the base channel for the event at 14:00, giving event E2.

Five channel NVOD system.

The base channel, which contains the time_shifted_service_descriptor() has six two-hour events per day. The child channels are delayed by one, two, three, and four hours

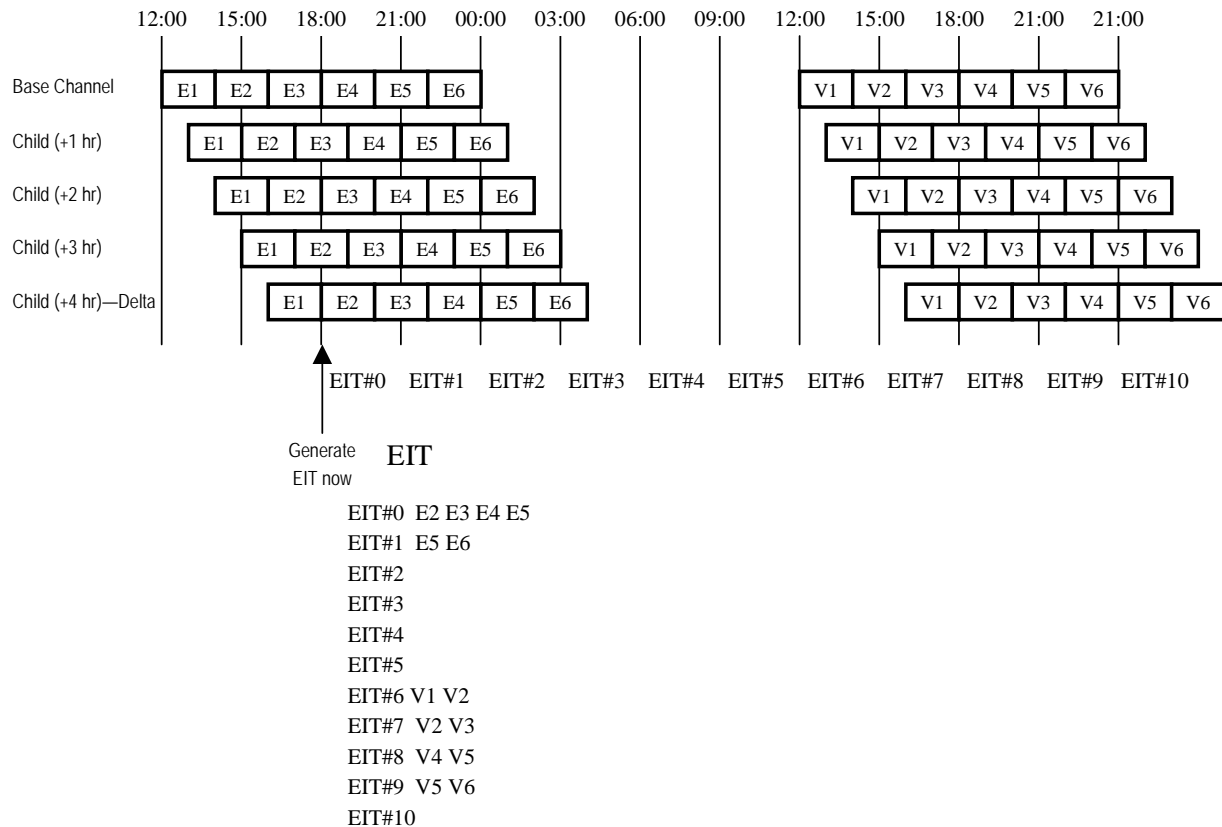

Figure D11 NVOD Example #2

Notes:

E1 has expired on channel Delta (the most delayed child); it is no longer listed in the EIT.

E2 & E3 have not expired on channel Delta (although they have expired on the base channel); they have to be listed in EIT#0.

EIT#1 and above are still the same as for a normal channel.

To find what event starts on channel Delta at 18:00 the steps are:

- 1) Subtract the channel’s time offset (4 hours) from 18:00, giving 14:00.
- 2) Calculate which EIT window covers 14:00, giving EIT#-2 (i.e., minus two). A negative number is not legal for a window => We must use EIT#0.
- 3) Look in EIT#0 of the base channel for the event at 14:00, giving event E2.

9. INTERPRETATION OF MGT TABLE VERSION NUMBERS

On first glance, it may appear that the MGT simply provides the version numbers for table sections that make up the EIT/ETT tables for each timeslot. For example, the MGT may indicate a table_type_version_number of 5 for a table_type value of 0x0100 (EIT-0), which could lead one to say “EIT-0 is at version 5.” In fact, the MGT does give table version information for all

transmitted tables, but a careful and correct interpretation of the data provided, including `table_type_PID`, must be made to avoid errors in processing.

The proper interpretation of `table_type_version_number` is to consider it to reflect the `version_number` field in the referenced table. In accordance with MPEG-2 Systems, the scope of `table_version_number` is limited to table sections delivered in transport packets with a common PID value. For example, for table sections with a given value of `table_ID`, a table section delivered in transport packets with PID value 0x1E00 and `version_number` 6 must be interpreted as a separate and distinct table from a table section delivered in transport packets with PID value 0x1E01 and `version_number` 6.

The following example is designed to illustrate the distinction between the simple (incorrect) interpretation and the correct one. In the illustration, the incorrect interpretation leads to processing errors, which involve re-loading tables that have not in fact changed, or (more seriously) not updating tables that *have* changed.

For the following example, the time zone offset is 0. Each EIT table instance is associated with a separate PID (as per A/65 rules).

- 1) Say it's noon. From noon to 3 the following is true:
 - a) The EIT describing noon to 3 p.m. is in PID²⁰ 0x1000; version number is 0
 - b) The EIT describing 3 p.m. to 6 p.m. is in PID 0x1001; version number is 1
 - c) The EIT describing 6 p.m. to 9 p.m. is in PID 0x1002; version number is 0
 - d) The EIT describing 9 p.m. to midnight is in PID 0x1003; version number is 0
 - e) The MGT is at version 7 and indicates:
 - 1) EIT-0, PID 0x1000, version number 0
 - 2) EIT-1, PID 0x1001, version number 1
 - 3) EIT-2, PID 0x1002, version number 0
 - 4) EIT-3, PID 0x1003, version number 0
- 2) The time moves to 3pm, crossing a timeslot boundary. Let's say the EIT describing 6pm to 9 p.m. is changed now too.
 - a) The EIT for noon to 3 p.m. is no longer sent, since its time has passed
 - b) The EIT for 3 p.m. to 6 p.m. is still in PID 0x1001; version number is still 1
 - c) The EIT for 6 p.m. to 9 p.m. is still in PID 0x1002; but its content changed at the same time, so its version number is moved to 1
 - d) The EIT for 9 p.m. to midnight is still in PID 0x1003; version number is still 0
 - e) MGT moves to version 8 and indicates:
 - 1) EIT-0, PID 0x1001, version number 1
 - 2) EIT-1, PID 0x1002, version number 1
 - 3) EIT-2, PID 0x1003, version number 0

What is now EIT-0 did not change. What is now EIT-1 *did* change.

²⁰ The expression "in PID" as used here is a shorthand way of saying that the indicated table section is "carried in transport packets with a PID value equal to" the indicated value.

For this case, if the MGT is interpreted to give the version numbers of EIT-n for each value of n, the receiver will see the version of EIT-0 change from 0 to one and refresh it. It will decide the version of EIT-1 has not changed, and not refresh it. But both inferences are incorrect: in this example, EIT-0 has not changed, and EIT-1 *has* changed.

The correct interpretation involves processing version numbers with respect to the associated PID values. Looking at the same example, the MGT indicates that the table associated with PID 0x1001 did not change versions. Likewise, the table associated with PID value 0x1002 changed from version 0 to 1 and should be refreshed.

10. USE OF ANALOG TRANSMISSION SIGNAL ID

The Virtual Channel Table in PSIP associates a user-friendly definition of a service (a channel name and number) with the physical location of that service. Both digital and analog services are accommodated. For digital services, the Transport Stream ID (TSID) parameter defined in ISO/IEC 13818-1 (MPEG-2 Systems) [8] is used as a unique identifier at the TS level. For analog services, an identifier called the Transmission Signal ID (the acronym is also TSID) may be used.

The analog TSID, like its digital counterpart, is a 16-bit number that uniquely identifies the NTSC signal within which it is carried. CEA-608-B [3] Section 9.5.2.4 defines the data format for carriage of the Transmission Signal ID within eXtended Data Service (XDS) packets in the NTSC Vertical Blanking Interval.

In the US, the DTV system is designed with the expectation that the analog TSID will be included in any NTSC broadcast signal referenced by PSIP data. Whenever PSIP data provides a reference to an analog service, the receiver is expected to use that service's analog TSID to make a positive identification. The receiver is expected to not associate any channel or program information data with an NTSC service that does not broadcast its analog TSID.

11. USE OF COMPONENT NAME DESCRIPTOR

The `component_name_descriptor()` provides a mechanism to associate a multilingual textual label with an Elementary Stream component of any MPEG-2 program. If the program consists of one video stream and one audio track, such a label would not give much value. A program may be offered multilingually, for example with separate French and English tracks. In that case, a receiving device may choose, without need for user intervention, the track corresponding to the language set up as the user's preferred language.

It may be, however, that the service happens to have two English-language audio tracks of the same audio type (for example both may be Complete Main audio tracks). In another case, one or more of the audio tracks may not be associated with a spoken language. An example of such a track, sometimes called "clean effects," is ambient sound such as crowd noise from a sporting event. In both of these cases, use of the `component_name_descriptor()` is mandatory by the rules established in this Standard. The net result is that a display device will always have sufficient information to either choose an audio track by its language, by its type, or will have text describing each track that can be used to create an on-screen user dialog to facilitate the user's choice.

Annex E: Typical Size of PSIP Tables (Informative)

1. OVERVIEW

The typical sizes for the PSIP tables (STT, MGT, VCT, RRT, EIT and ETT) are calculated in this Section. The notation used here for the different equations is listed in the Table E1.

Table E1 Symbols

Symbol	Description
P	number of EITs (4 to 128)
C	number of virtual channels (analog and digital) per EIT
Cd	number of digital channels per EIT
E	number of events per EIT
R	number of rating regions
D	average number of rating dimensions defined per rating region
Dr	average number of rated dimensions per rating region
L	average number of rating values per rating dimension

2. SYSTEM TIME TABLE (STT)

The typical size for the STT is 20 bytes, with the assumption of having no descriptors.

3. MASTER GUIDE TABLE (MGT)

The typical size for the MGT (in bytes), based on the assumptions listed in the column “Assumption”, is shown in Table E2

Table E2 Typical Size (bytes) of MGT

Part	Size (bytes)	Assumption
PSI header and trailer	13	
message body	$26+22 \cdot P$	1. With one Terrestrial VCT, one RRT instance, P EITs and P event ETTs 2. No descriptors
Total	$39+22 \cdot P$	

4. TERRESTRIAL VIRTUAL CHANNEL TABLE (TVCT)

The typical size of the TVCT (bytes), based on the assumptions listed in the column labeled “Assumption” is shown in Table E3.

Table E3 Typical TVCT Size (bytes)

Part	Size (bytes)	Assumption
PSI header and trailer	13	1. All TVCT messages are carried in one section.
message body	$3+32^*C$	
extended channel name descriptor	20^*C	2. One string and one segment per string for long channel name text. 3. Long channel name text is compressed by Huffman coding with a standard table, and the text length after compression is 10 bytes
service location descriptor	23^*Cd	4. Three elementary streams per virtual channel for digital channels.
Total	$16+52^*C+23^*Cd$	

5. RATING REGION TABLE (RRT)

The typical size (in bytes per rating region) of the RRT, based on the assumptions listed in the column “Assumption”, is shown in Table E4.

Table E4 Typical Size (in bytes per rating region) of RRT

Part	Size (bytes per rating region)	Assumption
PSI header and trailer	13	1. One section only.
message body	$24+D^*(14+ 26^*L)$	2. One string and one segment per string for all text. 3. Rating region name text is compressed by Huffman coding with a standard table, and the size after compression is 12 bytes. 4. Dimension name text is compressed by Huffman coding with a standard table, and the size after compression is 4 bytes. 5. Abbreviated rating value text is compressed by Huffman coding with a standard table, and the size after compression is 2 bytes. 6. Rating value text is compressed by Huffman coding with a standard table, and the size after compression is 6 bytes. 7. No descriptors.
Total	$37+D^*(14+26^*L)$	

6. EVENT INFORMATION TABLE (EIT)

The typical size of the EIT (in bytes per virtual channel per EIT), based on the assumptions listed in the column “Assumption”, is shown in Table E5.

Table E5 Typical Size (bytes per virtual channel per EIT) of EIT

Part	Size (bytes per virtual channel per EIT)	Assumption
PSI header and trailer	13	1. One section only
message body	$1+40 \cdot E$	2. One string and one segment per string for title text. 3. Title text is compressed by Huffman coding with a standard table, and the size after compression is 10 bytes. 4. Two AC-3 descriptors @ 5 bytes each..
closed captioning service descriptor	$9 \cdot E$	5. number_of_services = 1.
content advisory descriptor	$(3+R \cdot (3+2 \cdot D)) \cdot E$	6. No rating_description_text.
Total	$14+(52+R \cdot (3+2 \cdot D)) \cdot E$	

7. EXTENDED TEXT TABLE (ETT)

The typical size for the ETT (in bytes per event per EIT), based on the assumptions listed in the column labeled “Assumptions,” is shown in Table E6.

Table E6 Typical Size (bytes per virtual channel or bytes per event) of ETT

Part	Size (bytes per event per EIT)	Assumptions
PSI header and trailer	13	
message body	92	1. A virtual channel or an event can have one text string and one segment per string for the extended text message. 2. Extended text message is compressed by Huffman coding with a standard table, and the size after compression is 88 bytes. 3. Channel ETTs are typically not needed.
Total	105	

8. DIRECTED CHANNEL CHANGE TABLE (DCCT)

The typical size for the DCCT is 44 bytes, with the assumption of having a single from/to channel, a single selection criterion, and no additional descriptors. The typical size for the DCCT (in bytes) based on the assumptions listed in the column “Assumption” is shown in Table E7.

Table E7 Typical Size (bytes) of DCCT

Part	Size (bytes)	Assumption
PSI header and trailer	13	
message body	$3+(17 \cdot D)+(11 \cdot S)$	1. No descriptors. 2. D = number of DCC opportunities defined. 3. S = number of selection criteria.
Total	$16+(17 \cdot D)+(11 \cdot S)$	

9. DIRECTED CHANNEL CHANGE SELECTION CODE TABLE (DCCSCT)

The typical size for the DCCSCT is 72 bytes, with the assumption of having four extra genre code categories and no additional descriptors. The typical size for the DCCSCT (in bytes) based on the assumptions listed in the column “Assumptions” is shown in Table E8.

Table E8 Typical Size (bytes) of DCCSCT

Part	Size (bytes)	Assumptions
PSI header and trailer	13	
message body	$3+(Sg*(5+9))$	1. No descriptors. 2. Sg = number of genre category updates 3. Genre category name is compressed by Huffman coding with a standard table, and the length of the MSS after coding is 9 bytes.
Total	$16+(Sg*14)$	

10. AN EXAMPLE FOR TERRESTRIAL BROADCAST

Suppose that a TV provider is in charge of two physical transmission channels, one for analog and the other for digital services. Assume that the digital Transport Stream carries five virtual channels (NTSC plus four digital), each with an average of 4.5 events in each of EIT-0, EIT-1, EIT-2 and EIT-3. For each virtual channel an extended channel name descriptor is present. For each event an extended text message is available. Regarding the Rating Region Table, suppose that a different rating region than that given in the example of Annex D Section 4.4 is used, and it is defined with six dimensions and five values per dimension. The example assumes this system and that a typical content advisory uses two of the six dimensions. No Channel ETTs are used.

Based on these assumptions, typical sizes for every PSIP table can be calculated. The results are listed in Table E9 and Table E10.

Table E9 Typical Sizes of PSIP tables (except ETT) for the Example

Part	Size in bytes (excluding Transport Stream packet header)	Size in Transport Stream packets
STT	20	1
MGT	127	1
TVCT	368	2
RRT	901	5
Subtotal for tables identified by the base_PID	1,416	8
EIT-0	1,398	8
EIT-1	1,398	8
EIT-2	1,398	8
EIT-3	1,398	8
Total	7,008	39

Table E10 Typical Sizes of ETTs for the Example

Part	Size in bytes (excluding Transport Stream packet header)	Size in Transport Stream packets
Channel ETT	0	0
Event ETT-0	2,835	16
Event ETT-1	2,835	16
Event ETT-2	2,835	16
Event ETT-3	2,835	16
Total	11,340	62

Annex F: An Overview of Huffman-based Text Compression (Informative)

1. INTRODUCTION

This section describes the Huffman-based text compression and coding methods supported in the Program and System Information Protocol. In particular, this section:

- Describes the partial first-order Huffman coding used to compress PSIP text data.
- Provides background description of finite-context Huffman coding. The mechanisms for generating and parsing Huffman codes are described.
- Describes the decode tree data structure.
- Defines the character set supported by this Standard.

2. DATA COMPRESSION OVERVIEW

Program and System Information data may use partial first-order Huffman encoding to compress English-language text. The Huffman-table based approach has the following features:

- A typical firmware-resident Huffman decode table requires less than 2K of storage.
- The encode and decode algorithms are relatively simple and fast.
- Since first-order Huffman codes are significantly influenced by language phonetics, codes produced from a sample of current program titles produce reasonable compression ratios for future program titles, even though the future program titles may be significantly different from current titles. Therefore, hard-coded tables stored in receiver non-volatile memory are helpful.

The data compression approach has the following implementation characteristics:

- Program descriptions and program titles may use different Huffman codes. Titles and descriptions have significantly different text characteristics; for example, program titles usually have an upper-case character following a space character, whereas program descriptions usually have a lower-case character following a space-character.
- Hard-coded decode tables, one optimized for titles and one for descriptions, must reside in the receiver's non-volatile memory.

3. OVERVIEW OF CONTEXT-SENSITIVE HUFFMAN CODING

Each and every character does not occur with the same frequency in program titles and program descriptions. For example, the character "e" occurs more often than the character "x." With Huffman coding, the number of bits used to represent a character is inversely proportional to the character's usage frequency.

The Huffman coding compression ratio depends upon the statistical distribution of the characters being compressed. When character usage is uniformly distributed, no compression is achieved with Huffman coding. To achieve satisfactory compression, the Huffman codes are generated using statistics that match the data being compressed. For example, Huffman codes generated from Pascal computer programs would be less than ideal for compressing C programs.

For text strings in the PSIP, program descriptions and program titles may be compressed with different sets of Huffman codes.

Context-sensitive Huffman coding recognizes that a character's usage statistics are context dependent. For example, the character "u" has a high probability of occurrence after the character "q". The "order" of the Huffman code defines the "look-back" context by which a character is coded. With order-0, each character is coded independently of the previous character. With order-1, the Huffman code used to represent a given character depends upon the previous character. In zero-order Huffman compression, the occurrence probability of the alphabet elements is used to develop an optimal encoding tree. In first-order Huffman, the conditional probability of a character, given that the previous character is known, is used as the basis of a decoding tree. For this reason, while zero-order Huffman has typically a single tree, first-order Huffman has many, one for each character.

Huffman compression involves the following steps:

- Determine the statistical distribution of the characters or symbols in the source data.
- Create Huffman codes from this statistical information.
- Encode the source data: Translate each character into its corresponding Huffman code.

To decompress the coded data, the data string is parsed bit-by-bit and translated to the original characters. To do this, the decompressor must have the correct decode table, which maps the Huffman codes to their corresponding characters. The following example illustrates the generation and decoding of Huffman codes.

3.1 Example

Huffman codes are mapped to their corresponding characters using a binary tree structure. The leaves of this tree are the alphabet elements to be coded. The tree is produced by recursively summing the two nodes in the tree with the lowest usage frequency. For the following example (Table F1), assume that an alphabet contains the following twelve characters which occur a certain number of times in the sample database:

Table F1 Example Character Set and Frequency of Character Occurrence

Character	Occurrence Number
'a'	144
'b'	66
'c'	30
'd'	30
'e'	18
'f'	12
'g'	6
'h'	1
'i'	1
'j'	1
ESC	arbitrary

The "escape" character is inserted into the table to handle input characters which rarely occur, and have no corresponding Huffman codes. In this example, no Huffman codes will be

generated for the characters 'h', 'i', and 'j'. Instead, their frequencies will be summed into the ESC character. Whenever one of these characters occur in the input stream, the encoder inserts the ESC Huffman code, then inserts the original ASCII value for that character.

Figure F1 shows the construction of the Huffman tree from the character frequencies. The two nodes with the lowest frequencies, ('ESC' and 'g'), are joined together, with a resulting node weight of (9). The next two lowest nodes, ('f' and the intermediate node), are then joined together, with the combined weight of (21). This process continues until the tree's root node is formed. Once the tree is completed, the bit (1) is assigned to all right-hand branches, and the bit (0) is assigned to all left-hand branches.

Decoding a Huffman string is straight-forward. Starting at the Huffman tree root, the decoder parses the string, bit by bit, until it reaches a leaf node. The leaf node is the decoded character. The decoder then moves back to the root of the Huffman tree to continue decoding the bit string. For example, the input string 10111011100010 would be decoded into 'beeaab'.

This example uses order-0 Huffman codes. With order-1, each character in the alphabet has an associated tree of Huffman codes for possible succeeding characters. The ESC character would be inserted into each of these order-1 tables to handle statistically unlikely character pairs.

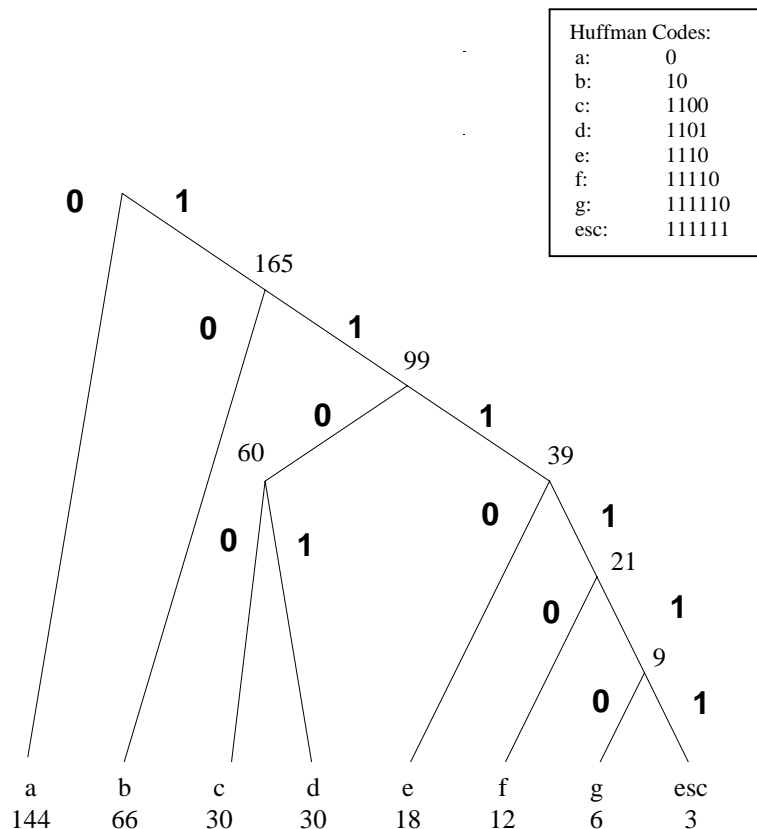

Figure F1 Example Huffman tree.

3.2 Decode Tree Example

Actual implementations of Huffman decoders need to map the trees into a suitable data structure that can be used by a computer or processor to traverse the tree top-down. In Annex C, a possible method for representing the trees was described and explicitly defined. Such a method is used here to build the decoding tree data for the example given in Figure F1. Although an order-0 tree, this table is representative of order-1 decode trees, except that the bytes of each order-1 tree start at a byte location specified by the corresponding tree root offset (rather than starting at location 0), shown in Table F2.

Table F2 Decode Tree Example

Byte #	Left/Right Child Word Offset or Character Leaf	
0 (tree root)	225	(ASCII "a" + 128)
1	1	(word offset of right child)
2 (tree node)	226	(ASCII "b" + 128)
3	2	(word offset of right child)
4 (tree node)	3	(word offset of left child)
5	4	(word offset of right child)
6 (tree node)	227	(ASCII "c" + 128)
7	228	(ASCII "d" + 128)
8 (tree node)	229	(ASCII "e" + 128)
9	5	(word offset of right child)
10 (tree node)	230	(ASCII "f" + 128)
11	6	(word offset of right child)
12 (tree node)	231	(ASCII "g" + 128)
13	155	(ASCII "ESC" + 128)

3.3 Encoding/Character Decoding Examples with 1st-order Huffman tables

As an example of using the Huffman table defined in Table C4 in Annex C, here we show the procedure to encode and decode the string "The next" using the tables optimized for titles. The coding sequence that generates the bit stream for "The next" is described in Figure F2.

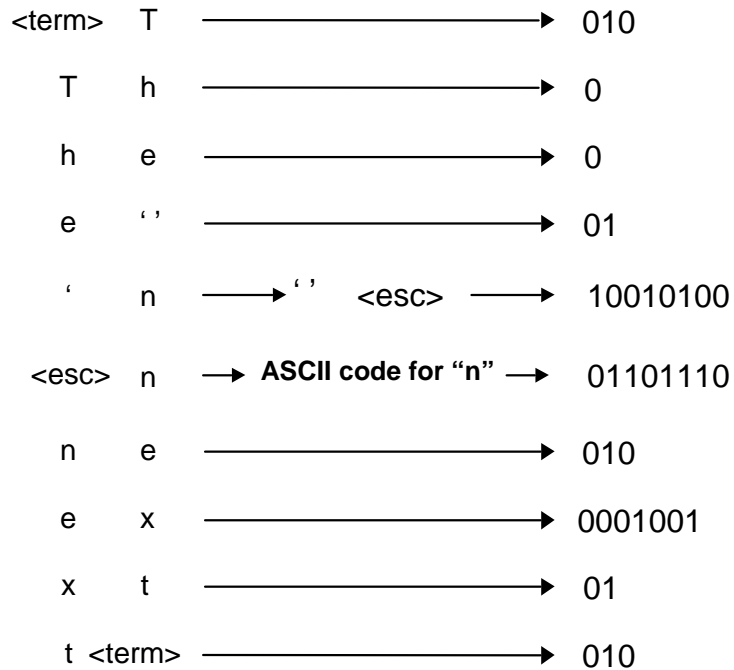

Figure F2 Coding example for the string “The next”.

The first character ‘T’ is encoded assuming that the previous one was a *terminate* character. The second letter ‘h’ is encoded based on the Huffman tree corresponding to the prior symbol ‘T.’ The sequence proceeds as shown in the Figure. The combination blank-space followed by an ‘n’ is not listed in the tree, thus the escape character is used to switch the coding process to uncompressed mode. Once in this mode, the ‘n’ is encoded using its standard 8-bit ISO Latin-1 value. After the ‘n’, an ‘e’ is encoded using the appropriate n-tree and the algorithm continues until reaching the final letter followed by a string-terminate character. Uncompressed transmission of this string requires 9 bytes, while after compression, only 39 bits, equivalent to 5 bytes, are needed.

Decoding requires traversing the different trees top-down. As an example, Figure F3 shows the tree when the prior character is ‘x’. From our example, after decoding the letter ‘x’, the remaining bit sequence is ‘01010’. Traversing the x-tree top-down using this sequence shows that ‘01’ corresponds to ‘t’, a newly decoded character. The process now jumps to the t-tree and so on, to decode the remaining bits until the terminate code results. Notice that the trees can be obtained by examining the encoding tables or by following the semantics of the provided decoding tables.

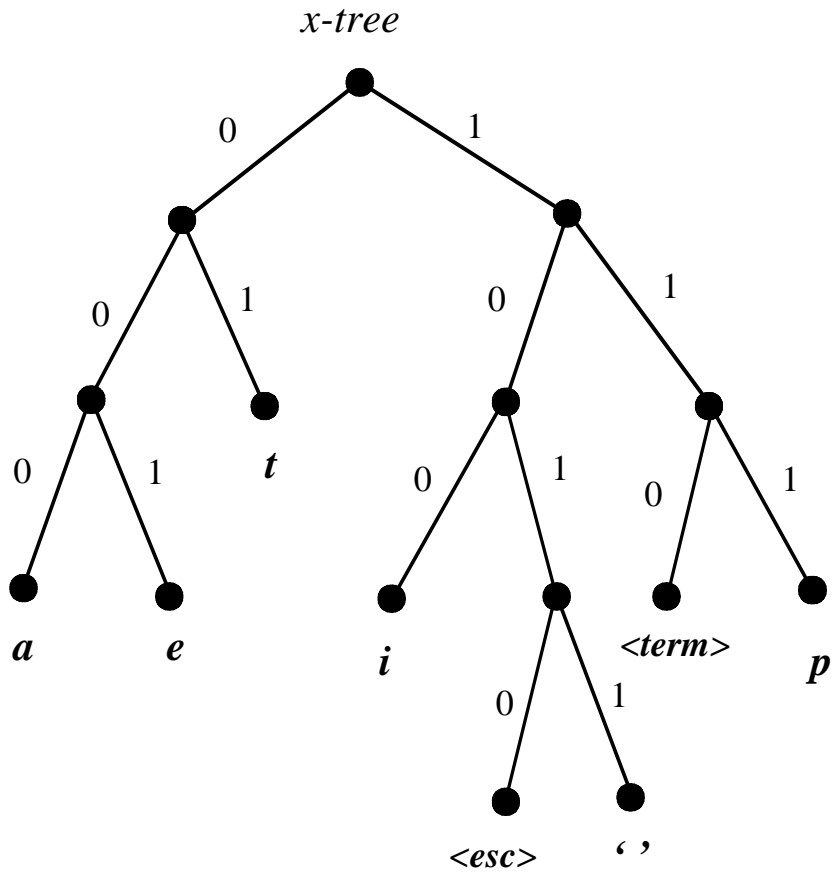

Figure F3 Huffman tree for prior symbol “x”.

Annex G: An Overview of PSIP for Cable (Informative)

1. INTRODUCTION

As described in this standard, certain data specified in the Program and System Information Protocol (PSIP) forms a mandatory part of every ATSC-compliant digital multiplex signal delivered via terrestrial broadcast. Annex D provides an overview of the use of PSIP for the terrestrial broadcast application. This Annex supplements that discussion, focusing on the use of PSIP for digital cable.

2. OVERVIEW

PSIP was designed, as much as possible, to be independent of the physical system used to deliver the MPEG-2 multiplex. Therefore, the System Time Table, Master Guide Table, Virtual Channel Table (VCT), and Event Information Tables and Extended Text Tables are generally applicable equally as well to cable as to terrestrial broadcast delivery methods. The differences can be summarized as follows:

- For cable, the Cable Virtual Channel Table (CVCT) provides the VCT function, while the Terrestrial Virtual Channel Table (TVCT) applies for terrestrial broadcast. The cable VCT includes two parameters not applicable to the terrestrial broadcast case, and the semantics of several parameters in the table are slightly different for cable as compared to the terrestrial broadcast case. The specifics are discussed in Section 3 of this Annex.
- While the standard requires delivery of the first four EITs (EIT-0-3) in the case of terrestrial broadcast, no such requirement exists for the cable. Inter-industry agreements and FCC regulations, however, have established certain practices with regard to the carriage of PSIP data when provided to the cable operator by the program provider, including terrestrial broadcast. Section 7 describes these regulations and agreements.

3. COMPARING CVCT AND TVCT

While the syntax of the Cable and Terrestrial VCTs are nearly identical, the Cable VCT has two parameters not present in the Terrestrial VCT: a “path select” bit, and a bit that indicates whether a given virtual channel is transported in-band or out-of-band (OOB). Also, the semantics of the major and minor channel number and the `source_id` fields differ for the Cable VCT as compared with its terrestrial broadcast counterpart.

3.1 Path Select

Use of the path select is required when PSIP is used in a cable network in which two separate physical cables are present (a rare situation). In such a case, the value of the `path_select` bit indicates whether the receiver should select the cable connected to its primary port (“path 1”) or the secondary cable (“path 2”). It may be noted that Uni-Directional Cable-Ready devices as defined by the FCC (47 CFR §15.123) [21] are not required to support two-path cable systems or the `path_select` bit.

3.2 Out of Band

When a cable virtual channel is flagged as being “out of band,” it is carried on the out-of-band channel (the data channel made available by the presence of a cable-operator supplied module in the consumer cable-ready receiver). If a receiver is implemented with a dedicated OOB tuner, it can select and process the OOB multiplex if a user chooses a virtual channel flagged as `out_of_band`. Receivers not capable of receiving or processing data on out-of-band carriers may use the `out_of_band` flag as a way to skip or ignore them.

3.3 Major and Minor Channel Numbers

When PSIP is used for terrestrial broadcast, care must be taken in the assignment of major and minor channel numbers to avoid conflicts. For example, this Standard specifies in Annex B that for the US and its possessions, a terrestrial broadcaster with an existing NTSC license must use a major channel number for digital services that corresponds to the NTSC RF channel number in present use for the analog signal. For cable, such restrictions are technically unnecessary, as long as there is no duplication of numbers on a given cable system. The use or potential re-assignment of a broadcaster’s major channel number is beyond the scope of this standard. For terrestrial broadcast, the major channel number is limited to the range 1 to 99 for ATSC digital television or audio services. For cable, major channel numbers may range from 1 to 999.

For minor channel numbers, this Standard specifies that zero shall be used for NTSC analog television services, 1 to 99 for ATSC digital television or audio only services, or 1 to 999 for data services. Minor channel numbers for cable, on the other hand, have no restrictions on use: they can range from 0 to 999 for any type of service.

3.4 Source IDs

The `source_id` parameter is defined identically between cable and terrestrial broadcast VCTs, except that for the cable case, value `0x0000` indicates that the programming source is not identified. Value zero is therefore valid for cable but is reserved (not presently defined) for terrestrial broadcast.

A `source_id` with value zero is useful for cases where a cable operator wishes to define a channel for which no EPG data is currently available. If any virtual channel contains a value of zero in this field, that virtual channel has no linkage to EPG data. Assignment of a value for `source_id` for any given service should remain constant over time because changes may disrupt user applications. For example, programs targeted for future storage may be identified by `source_id`, and any change would result in failure to achieve the desired recording.

4. IN-BAND VERSUS OUT-OF-BAND SYSTEM INFORMATION

Cable operators often make use of one or more out-of-band (OOB) control channels. OOB control gives the operator nearly guaranteed access to each set-top box (or cable-ready receiver) in use on a cable network, because a dedicated tuner in each remains tuned to the OOB channel independent of where the user might choose to tune the frequency-agile tuner while accessing various services.

PSIP data on cable is provided in-band so that cable-ready consumer electronic equipment can receive navigation data without having to process an OOB channel. Some custom, cable system-specific receiving devices may supplement the PSIP data by making use of other data,

provided that the delivery of such data does not conflict with any requirements of the PSIP specification.

5. USING PSIP ON CABLE

PSIP data carried on cable in-band is analogous to PSIP included in the terrestrial digital broadcast multiplex: a receiver can discover the structure of digital services carried on that multiplex by collecting the current VCT from it. A cable-ready digital TV can visit each digital signal on the cable, in sequence, and record from each a portion of the full cable VCT. This is exactly the same process a terrestrial digital broadcast receiver performs to build the terrestrial channel map.

5.1 Terrestrial Virtual Channel Maps on Cable

If a cable operator chooses to deploy digital cable boxes in a cable network, to properly support the cable terminals, that network will need to conform to the transmission and transport standards defined through the Society of Cable Telecommunications Engineers (SCTE). In some instances, however, a small cable operator may offer a cable service in which no cable boxes are required. That operator may wish to implement a low-cost headend where off-air terrestrial broadcasts are simply received and placed onto the cable, as is done with a community antenna scheme such as SMATV. In some cases, signals may be shifted in frequency before being placed on the cable (such as to move a UHF frequency down to the VHF range).

In cases such as these, a receiver may encounter a Terrestrial Virtual Channel Table when it processes an 8-VSB signal Stream from the 75 Ω cable port on the receiver. Although the TS on such 8-VSB may not strictly conform to SCTE standards for digital cable, cable-ready receivers should nonetheless be designed to handle the case where a Terrestrial VCT is found where a Cable VCT is expected.

5.2 Use of the Cable VCT

Cable signals are transmitted in accordance with established frequency plans, so initially discovering the location of each digital or analog carrier is straightforward. PSIP data typically describes services carried on the same Transport Stream as the PSIP data itself (although it may describe other services on another TS). The `channel_TSID` value for these services is required to match the TSID value found in the PAT of the Transport Stream of the indicated service.

Whenever PSIP data references a service carried on a different digital Transport Stream or references an NTSC analog service, the `channel_TSID` should be used to positively identify the target TS or analog service. The recommended approach involves use of a digital signal's Transport Stream ID (TSID) and an analog NTSC signal's Transmission Signal ID (analog TSID). The FCC has rules for the use of both the TSID and the analog TSID by each broadcast station operator in the US. Each station has two unique TSID values, one for analog and one for digital transmission. The digital TSID is defined by the MPEG-2 *Systems* specification, ISO/IEC 13818-1. Transport of the analog TSID is defined in CEA-608-B; it is simply a 16-bit signal identifier that is carried in an Extended Data Service (XDS) packet.

Upon initial setup by an installer or consumer, a receiver should perform an automatic scan of all frequencies where analog or digital signals may be found.²¹ The frequencies used for the scan correspond to standard frequency plans for off-air broadcast or cable, as appropriate. When a signal is found at a given frequency, the receiver should take note of the analog or digital TSID. Although not all analog signals are required to include TSIDs, all digital transport streams are required to carry the a TSID. The TSID for each TS referenced by a CVCT needs to be unique on that cable system for PSIP-based tuning to be effective.

When asked to acquire a specific service, the receiver should use the frequency upon which it was last found and verify the TSID.

The data in the modulation field may be in error unless the cable system modifies it. The SCTE has standardized two modulation modes for cable television transmission of digital television. The terrestrial broadcast PSIP shall indicate ATSC 8-VSB modulation for over-the-air transmission of digital television. Any receiver that does not have access to an out-of-band data stream indicating the modulation modes of the various carriers on the network will need to be designed to acquire any of the modes that may be present. In the US, 64-QAM, 256-QAM, or 8-VSB modulation may be encountered.

5.3 Service Location on Cable

The `service_location_descriptor()` indicates the stream types, PID and language code for each member of the collection of program elements that comprise a virtual channel. As mentioned, one of the differences between the terrestrial and cable is that the `service_location_descriptor()` is not required in the Cable VCT, even though its use is mandatory for the Terrestrial VCT. The difference arises from the fact that cable operators may re-multiplex digital Transport Streams that are available to them, adding, deleting or moving services to create cable Transport Streams, and some services may not have the information needed to facilitate creation of the `service_location_descriptor()`. Some cable system equipment does not have the capability to format the information into the `service_location_descriptor()` when the information is available. A motivation for re-multiplexing is that the data rate for information on cable is typically higher than that available from terrestrial broadcast transmissions, and a cable operator may wish to construct multiplexes that make full use of the channel capacity.

Therefore, when there is no `service_location_descriptor()`, the receiver or set-top box needs to learn the structure of each service via the `TS_program_map_section()` which contains essentially the same information as the `service_location_descriptor()`. ATSC (and SCTE) Standards require the presence and correct construction of the `TS_program_map_section()`.

A typical cable receiver or set-top box may implement a scheme where the last-used PID values for audio and video streams are stored with each VCT record in the device's memory. Initial acquisition of a virtual channel may be slower by as much as 400 milliseconds (the maximum interval between repetitions of the `TS_program_map_section()`) since the `TS_program_map_section()` will need to be processed to learn the PID values, but this delay can be avoided on subsequent acquisitions by making use of the stored values. In any case, one step in the acquisition process should always be to check the current `TS_program_map_section()` to verify

²¹ It is strongly recommended that such a scan is done also when the receiver is in the "off" state to refresh VCT and program guide data.

that the PID values have not changed since the last acquisition of the service. If they have changed, the new values replace the old.

5.4 Analog Channel Sharing

Some cable operators time-share certain 6-MHz slots between two analog television services, switching from one to the other on a daily schedule. If PSIP were to be used (out of the NTSC band) to describe such a shared analog channel, two approaches are possible:

- Define the channel as a single entity, using one `source_id`. The channel name may be a combination of the two service names, such as “WXYZ/USTV” for example. Or it could be a neutral name such as “Combo.” Since the channel is defined as a single entity in PSIP, it appears as one horizontal grid line on the EPG display.
- Define the channel using two `source_id`s, one for the first source and another for the second. It is possible to assign each source a separate channel name. Both sources could be assigned the same channel number and frequency, corresponding to the channel’s band number on the cable. Use of the RF channel number is necessary for consistency between DTV receivers using PSIP and analog receivers that tune and number using the conventional analog method. On the EPG grid, each of the services are expected to show “Off the air” (or equivalent) during the part of the broadcast day when the transmission channel is being used for the other source.

The second case represents an unusual situation for the DTV receiver, in that two services share the exact same channel number. If the user selects such a doubly-defined channel by direct entry of the number, the frequency is unambiguous so the receiver can tune straightforwardly. If the receiver would wish to display the proper channel name or program name, it must rely on the analog TSID to properly identify the received signal.

In both of these cases, it is the responsibility of the cable headend to perform source switching as necessary to create the composite channel.

6. RE-MULTIPLEXING ISSUES

As mentioned, a cable operator may take incoming digital Transport Streams from various sources (terrestrial broadcast, satellite, or locally generated), add or delete services or elementary streams, and then re-combine them into output Transport Streams. If the incoming Transport Streams carry PSIP data, care must be taken to properly process this data in the re-multiplexer.

Specifically, the re-multiplexer needs to account for any MPEG or PSIP fields or variables that are scoped to be unique within the Transport Stream. Such fields include PID values, MPEG `program_numbers`, `source_id` tags that are in the range 0x0001 through 0x0FFF and `event_id` fields.

Other PSI and PSIP-related tasks that need to be performed include:

- Construct an output Virtual Channel Table represents the virtual channels that will be included in the resulting Transport Stream.
- Combine EIT and ETT data from the various sources and remove data for any deleted services. (Rules for deleting services are beyond the scope of this standard.)
- Construct the output Rating Region Table to include all regions that the cable operator is either required to support or chooses to support.
- Rebuild the Master Guide Table to represent the resulting PSIP tables.

- The `service_location_descriptors` present in incoming Terrestrial Virtual Channel Tables may not be deleted, but in order to identify all the services in the Cable Virtual Channel Table for a new transport stream, they may need to be modified (if they are no longer accurate because of PID changes). The business and regulatory processes related to PID changes and this modification are outside the scope of this Standard.
- Edit the MPEG-2 Program Map Table to accurately reflect the Transport Stream PID values for all elementary streams in each service.

The special case of remultiplexing without adding or dropping content in the source transport stream does not require PSIP modification, as long as other services being added during the remultiplexing do not have conflicting PID values and use `TS_program_map_section()`s that do not conflict with the source streams containing PSIP data. This mode may be particularly attractive when 64 QAM is used, as only the PAT would need to be updated by the multiplexer combining the elements.

7. THE TRANSITION TO PSIP ON CABLE IN THE UNITED STATES OF AMERICA

The first digital cable boxes to employ MPEG-2 transport and video coding were deployed in North America beginning in 1996. This PSIP standard was developed and approved by the ATSC in 1997. In 1998, the use of PSIP on cable was balloted and approved by the Digital Video Subcommittee of SCTE.

Cable systems supporting Uni-Directional Digital Receiving Devices provide an out-of-band control channel for system control and addressing of these boxes. System Information in accordance with ANSI/SCTE 65 2002 provides navigational information such as the cable frequency plan in use, the channel line-up, and channel names and numbers. This standard uses the same virtual channel map approach that PSIP uses.

Federal regulations adopted by the FCC (47 CFR §76.640) require cable operators to include A/65 PSIP data including virtual channel tables and event information to describe services carried in-the-clear, when such PSIP data is made available to them from the content provider. This same section of the FCC rules states that System Information carried out-of-band must include a textual channel name for each channel carrying a scrambled service.

8. DATA RATES FOR PSIP ON CABLE

The typical sizes of PSIP data in the cable application are computed here. Since the structure of the PSIP tables is unchanged from the terrestrial application, the analysis of table sizes found in Annex E of the PSIP Standard applies equally well to cable. On cable, the `service_location_descriptor()` is optional, however, so the CVCT data size may be reduced by $(23 * C_d)$ where C_d represents the number of digital services in the multiplex.

If the CVCT is repeated at a rate of 2.5 repetitions per second, and we say that there are 10 digital channels and one reference to an analog channel, the total data rate for each instance of the CVCT is

$$\begin{aligned} R_{CVCT} &= (\text{size of CVCT in bytes}) * (8 \text{ bits/byte}) * (\text{table repetition rate}) \\ &= (16+52*11) * 8 * 2.5 = 11,760 \text{ bps} \end{aligned}$$

If the MGT is repeated at a rate of one repetition each 150 milliseconds, and it includes references to EIT-0 through -3, the data rate for the MGT content is

$$\begin{aligned} \text{RMGT} &= (\text{size of MGT in bytes}) * (8 \text{ bits/byte}) * (\text{table repetition rate}) \\ &= 138 * 8 * 1 / .15 = 7360 \text{ bps} \end{aligned}$$

If the RRT is repeated at a rate of one repetition per minute, assuming one region with nine dimensions and an average of four levels per dimension, the data rate is

$$\begin{aligned} \text{RRRT} &= (\text{size of RRT in bytes}) * (8 \text{ bits/byte}) * (\text{table repetition rate}) \\ &= (37+9*(14+26*4)) * 8 * 1/60 = 1099 * 8 / 60 = 147 \text{ bps} \end{aligned}$$

If the STT is repeated at a rate of once per second the data rate is

$$\text{RSTT} = 20 * 8 = 160 \text{ bps}$$

So, the total data rate for tables required for the cable application is

$$\begin{aligned} \text{RTOTAL} &= \text{RCVCT} + \text{RMGT} + \text{RPAD} + \text{RRRT} + \text{RSTT} \\ &= 11,760 + 7360 + 4907 + 147 + 160 = 19.427 \text{ kbps} \cong 25 \text{ kbps} \end{aligned}$$

The analysis can be extended to include the case that EIT/ETT is present in the multiplex, to refine it to reflect multiple table sections in packets with PID 0x1FFB, and to address padding bytes needed when MPEG-2 TS packets are not exactly filled.

Annex H:
Location Codes for Counties and Equivalent Entities of the United States, Its Possessions, and Associated Areas

Editorially Removed